

2022



reisen^{thel}[®]

SO SCHÖN GEHT VERANTWORTUNG TRAGEN

„Mehrweg statt Einweg“ war schon immer unser Credo und reisenhel war damit Vorreiter in Sachen Nachhaltigkeit. Jetzt ist es auch der Stoff, aus dem unsere Produkte bestehen! Denn bei reisenhel treiben wir die Verwendung von robustem, ressourcenschonendem Obermaterial aus recycelten PET-Flaschen konsequent voran.

CARRYING RESPONSIBILITY WAS NEVER THAT BEAUTIFUL. "Reusable instead of disposable" has always been our credo, making reisenhel a pioneer in terms of sustainability. Now it's also the stuff our products are made of! Because at reisenhel we are consistently pushing the use of robust, resource-saving outer material made from recycled PET bottles.

TELLEMENT AGRÉABLE DE PRENDRE SES RESPONSABILITÉS. „Réutilisable au lieu de jetable“ a toujours été notre credo et de ce fait, reisenhel a été un pionnier de la durabilité. Maintenant, cela concerne également les matériaux dont sont faits nos produits ! En effet, reisenhel s'efforce de promouvoir l'utilisation de tissus de revêtement extérieurs à la fois robustes et respectueux des ressources, fabriqués à partir de bouteilles en PET recyclées.





100% NACHHALTIG 100% VERANTWORTUNG

Nachhaltigkeit steht neben Qualität und Funktionalität bei reisenhel absolut im Fokus. Und weil wir bei allem immer einen Schritt weitergehen, gehen wir beim Thema Nachhaltigkeit sogar einen Riesenschritt voran! In dieser Saison haben erstmals alle unsere Kollektions-Neuheiten ein Obermaterial aus recycelten PET-Flaschen. Ein Grund, sich zu freuen! Für uns und unsere Umwelt!

100 % SUSTAINABLE - 100 % RESPONSIBLE. In addition to quality and functionality, sustainability is paramount at reisenhel. And because we always go one step further with everything, we even take a giant step forward when it comes to sustainability! This season, for the first time, all of our new collections have an outer material made from recycled PET bottles. A reason to be happy! For us and our environment!

100 % DURABLE - 100 % RESPONSABLE. Chez reisenhel, la durabilité est une priorité absolue, au même titre que la qualité et la fonctionnalité. Et parce que nous allons toujours plus loin dans tout, nous faisons même un grand pas en avant en matière de durabilité ! Cette saison, pour la première fois, la matière du revêtement extérieur de tous les articles de notre nouvelle collection est fabriquée à partir de bouteilles PET recyclées. Une raison d'être heureux ! Pour nous et notre environnement !

VON DER FLASCHE ZUR TASCHE

BAGS MADE FROM BOTTLES | UN SAC FAIT DE BOUTEILLES



Plastikmüll durch PET-Flaschen ist global ein großes Problem. Deshalb schenken wir recycelten PET-Flaschen ein neues Leben und tun mit jeder Tasche etwas Gutes.

Plastic waste from PET bottles is a major global problem. That is why we give recycled PET bottles a new life and do something good with every bag.

La pollution due aux bouteilles plastiques est un problème mondial majeur. C'est pourquoi nous donnons une nouvelle vie aux bouteilles en PET en les recyclant et faisons une bonne action avec chacun de nos sacs.

Im mechanischen Recycling werden die Flaschen zu Granulat zerkleinert, gewaschen, eingeschmolzen, zu Chips geformt und zu neuen Fasern verarbeitet.

In mechanical recycling, the bottles are crushed into granulate, washed, melted down, formed into chips and processed into new fibers.

Le recyclage se fait essentiellement via des procédés mécanique. Les bouteilles sont broyées et réduites sous forme de paillettes qui sont ensuite lavées, fondues, purifiées et sont transformées en granulés de PET qui pourront devenir de nouvelles fibres polyester.



Aus den neuen strapazierfähigen Polyesterfasern entsteht das neue Obermaterial zahlreicher reisenthel Produkte, die unsere Ökobilanz verbessern und Spaß beim Einkaufen verbreiten.

The new outer material for numerous reisenthel products is made from the new, durable polyester fibers, which improve our ecobalance and make shopping fun.

À partir de ces bouteilles, il est donc possible de créer de la nouvelle fibre polyester résistante qui constitue le matériau textile de nos nouveaux produits cultes reisenthel qui améliorent notre bilan écologique et vous facilitent la vie de tous les jours.



WAS WIR AUS RECYCELTEN PET-FLASCHEN MACHEN? NEUE TASCHEN!

What do we do with recycled PET bottles? Make new bags!
Que faisons-nous à partir de bouteilles PET recyclées ? Des nouveaux sacs !

JEDE DIESER TASCHEN BESTEHT AUS
Each of these bags consists of | Chacun de ces sacs est composé de



RECYCELTEN PET-FLASCHEN
recycled PET bottles | bouteilles PET recyclées



NACHHALTIGKEIT LIEGT IN UNSEREN HÄNDEN. reisenhel hat schon immer den Fokus auf Langlebigkeit gesetzt und damit Verantwortung für die Umwelt übernommen. Einweg geben wir seit Jahren einen Korb.

SUSTAINABILITY IS IN OUR HANDS. reisenhel has always focused on longevity and thus taken responsibility for the environment. We have been rejecting single-use-bags for years.

LE DÉVELOPPEMENT DURABLE EST ENTRE NOS MAINS. reisenhel a toujours mis l'accent sur la longévité et a donc pris ses responsabilités vis-à-vis de l'environnement. Nous avons écarté les sacs jetables depuis des années.



RHOMBUS BLACK

EXQUISITE LOOK – SUPREME FEEL

3-D-Steppdesigns sind ein angesagtes Fashion-Thema. Mit rhombus black haben wir diesen Modetrend für unsere Taschen umgesetzt und stylish interpretiert: klassisch, urban und absolut raffiniert! Das neue Material mit Rauten-Bestickung ist aus unterschiedlichen Stofflagen perfekt komponiert und zeigt seine Hochwertigkeit auf den ersten Blick. Ein absolutes Highlight für jeden Look!

3-D quilted designs are a hot fashion topic. With rhombus black we have implemented and stylishly interpreted this fashion trend for our bags: classic, urban and absolutely sophisticated! The new material with diamond embroidery is perfectly composed of different fabric layers and shows its high quality at first sight. An absolute highlight for every look!

Les motifs matelassés 3D sont un thème très à la mode. Avec le losange noir, nous avons appliqué cette mode tendance à nos sacs et l'avons interprétée d'une manière élégante : classique, urbaine et absolument raffinée ! Le nouveau matériau en broderie losange est composé de différentes couches de tissu et montre sa haute qualité au premier coup d'œil. Un point fort absolu pour chaque look !



R

CARRYBAG



LOOPSHOPPER L



H

CLASSIC SHOPPER L



SHOPPER-BACKPACK



O

CLASSIC SHOPPER M



CASE 1



M

B

U

COSMETICPOUCH M



CARRYCRUISER



CLASSIC SHOPPER XL



CLASSIC BACKPACK M



DUFFELBAG M



S



T

WIST COLLECTION

Willkommen im Candy Shop! twist begeistert immer wieder neu. Dieses Mal in fünf unwiderstehlichen, soften Bonbonfarben, die je nach Look und Laune Fröhlichkeit versprühen oder edle Natürlichkeit zaubern. Ob süßer Beerenton, zartes Türkis, himmlisches Blau, stilvolles Braun oder charmantes Hellgrau: twist verleiht jedem Outfit das gewisse Etwas!

Welcome to the Candy Shop! twist always inspires anew. This time in five irresistible, soft candy colours that radiate cheerfulness or conjure up elegant naturalness, depending on the look and mood. Whether sweet berry, delicate turquoise, heavenly blue, stylish brown or charming light grey: twist gives every outfit that certain something!

Bienvenue au Candy Shop ! La collection twist ne cesse d'être une nouvelle source d'inspiration. Cette fois, elle se décline en cinq couleurs tendres et irrésistibles qui rayonnent de gaieté ou évoquent un naturel élégant, selon le look et l'humeur. Qu'il s'agisse de nuances baies sucrées, turquoises délicates, bleues paradisiaques, brunes élégantes ou d'un gris clair charmant, la collection twist donne à chaque tenue un petit quelque chose en plus !



C

CARRYBAG FRAME



LOOPSHOPPER L FRAME



O

ALLROUNDER L



SHOPPER XL



F

F

E

SHOPPER M



ALLROUNDER M



SHOPPER E1



CARRYCRUISER FRAME



ALLDAY BACKPACK M



ALLROUNDER R



ALLROUNDER CROSS



TOILETBAG XL



TWIST SKY ROSE

Auch feminin-elegant kann twist jetzt! Dezent und stylisch zugleich glänzt twist sky rose mit roségoldenen Metalldetails und überzeugt mit der edlen Kombination aus Rosé und zartem Grau. Dieses ultimative Design-Duo will man einfach haben und wird sicher schnell zum neuen Liebling für jeden Anlass!

Now twist can also be feminine and elegant! Discreet and stylish at the same time, twist sky rose shines with rose-gold metal details and impresses with the noble combination of rose and delicate grey. This ultimate design duo is a must-have and is sure to quickly become a new favourite for any occasion!

Aujourd'hui, le design twist peut aussi être féminin et élégant ! Discret et raffiné à la fois, le twist sky rose brille par ses détails métalliques en or rose et convainc grâce à la noble combinaison du rose et du gris délicat. Ce duo de design ultime est un must-have et deviendra rapidement une nouvelle pièce favorite pour toutes les occasions.



R

CARRYBAG FRAME



LOOPSHOPPER L FRAME



O

ALLROUNDER L



SHOPPER XL



S

K

Y

E

SHOPPER M



ALLROUNDER M



COOLERBAG



CARRYCRUISER FRAME



THERMOSHOPPER



SHOPPER E1



ALLROUNDER R



ALLROUNDER CROSS



TRAVELCOSMETIC



NEW COLLECTION 2022

DELIVERY DATES



RHOMBUS BLACK
BESTSELLER



TWIST SKY ROSE



ALLDAY
BACKPACK M



TWIST AZURE/
OCEAN

LIMITED
EDITION

DEC
21

JAN
22

FEB
22

MAR
22

LINE EXTENSIONS

CARRYBAG XS

MIXED DOTS RED
LINE EXTENSION

FLORIST PEACH/
LAGOON

TWIST BERRY



LIMITED
EDITION



FLORIST INDIGO





THERMO POP COLLECTION

LIMITED EDITION



OVERNIGHTER PLUS



TWIST COFFEE



SAFARI SAND

LIMITED EDITION

APR 22

MAY 22

JUN 22

JUL 22

AUG 22

RHOMBUS BLACK NEW PRODUCTS



OVERNIGHTER-BACKPACK M



SIGNATURE SUNSET



LIMITED EDITION

VIOLA BLUE/YELLOW/CELESTE/MAUVE

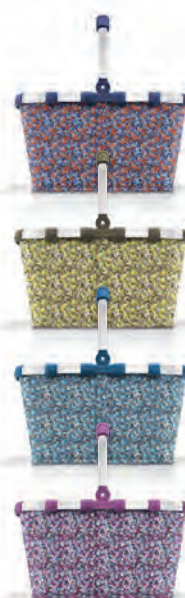

LIMITED EDITION



SHOPPING

CARRYBAG	22
CARRYBAG FRAME	24
CARRYBAG XS	26
RE-SHOPPER 1	27
LOOPSHOPPER L	28
EASYSHOPPINGBAG	30
BOTTLEBAG	31
SHOULDERBAG S	32
SHOPPER XS	33
SHOPPER M	34
SHOPPER E1	36
SHOPPER XL	38
CARRYCRUISER	40
CARRYCRUISER PLUS	42
CITYCRUISER RACK	44
CITYCRUISER BAG	45
TROLLEY M	46
FOLDABLETROLLEY	47
RHOMBUS BLACK	48

CARRYBAG®

**BEST
SELLER**

reisen^{thel}
ORIGINAL



↳ 48 x 29 x 28 cm

□ 22 l

VE/UNIT 4/12

Design Award 2004
DESIGN PLUS

□ Focus Know-how
Silber 2005



DESIGNPREIS
5
JAHRE
2005

REISEN^{THEL}

• **Das Original – heiß begehrt, weltbekannt und schon heute ein Klassiker!**

- Stabiler Aluminiumrahmen
- Weich ummantelter Griff zum Umklappen
- 1 Innentasche mit Reißverschluss
- Fester Boden mit Standfüßen
- bavaria 5: mit hochwertiger Samtschleife
- rhombus black: modernes 3-D-Steppdesign
- Optionales Zubehör: carrybag cover
- Belastbar bis 20 kg
- Material: hochwertiges Polyester-gewebe, wasserabweisend
- Recyceltes Obermaterial: robustes Polyestergewebe aus recycelten PET-Flaschen, wasserabweisend

• **The original: highly coveted, internationally known and already a classic today!**

- Sturdy aluminium frame
- Collapsible soft rubber handle
- 1 zip pocket inside
- Rigid bottom with base feet
- bavaria 5: with premium velvet bow
- rhombus black: modern 3-D quilted design
- Optional accessory: carrybag cover
- Loadable up to 20 kg
- Material: premium-quality polyester, water-repellent
- Recycled outer material: robust polyester fabric made from recycled PET bottles, water-repellent

• **L'original : un modèle plébiscité et mondialement connu. Déjà un classique !**

- Cadre stable en aluminium
- Poignée rabattable avec revêtement souple
- 1 poche intérieure zippée
- Fond rigide avec pieds
- bavaria 5 : avec un nœud en velours de haute qualité
- rhombus black : motif matelassé moderne en 3D
- Accessoire en option : carrybag cover
- Résistant jusqu'à 20 kg
- Matière : polyester de haute qualité, déperlant
- Matière principale recyclé : robuste tissu polyester fabriqué à partir de bouteilles PET recyclées, déperlant

CARRYBAG®



BK 2031*
viola yellow



BK 3004
red



BK 3070
signature red



BK 3074
bavaria 5 dark ruby



BK 3080*
viola mauve



BK 4027
twist blue



BK 4078
bavaria 5 blue



BK 4090*
viola celeste



BK 4091*
viola blue



BK 7003
black



BK 7027
baroque taupe



BK 7009
dots



BK 7059
rhombus black

CARRYBAG® COVER

↳ 48,5 x 6,5 x 28,5 cm

VE/UNIT 8/24



BP 4059
cover dark blue



BP 7003
cover black

CARRYBAG® FRAME

**BEST
SELLER**

reisetheil
ORIGINAL



↳ 48 x 29 x 28 cm

□ 22 l

VE/UNIT 4/12

Design Award 2004
DESIGN PLUS

□ Focus Know-how
Silber 2005



DESIGNPRE 5
2004

REISETHEIL

• **Das Original – heiß begehrt, weltbekannt und schon heute ein Klassiker!**

- frame: stabiler, farbig veredelter Aluminiumrahmen
- Weich ummantelter Griff zum Umklappen
- 1 Innentasche mit Reißverschluss
- Fester Boden mit Standfüßen
- bavaria 6: mit kreativem Print, Stickereien und Verzierungen
- Optionales Zubehör: carrybag cover
- Belastbar bis 20 kg
- Material: hochwertiges Polyester-gewebe, wasserabweisend
- Recyceltes Obermaterial: robustes Polyestergewebe aus recycelten PET-Flaschen (twist Material 50%), wasserabweisend

• **The original: highly coveted, internationally known and already a classic today!**

- frame: sturdy, colour-refined aluminium frame
- Collapsible soft rubber handle
- 1 zip pocket inside
- Rigid bottom with base feet
- bavaria 6: with creative print, embroidery and decorations
- Optional accessory: carrybag cover
- Loadable up to 20 kg
- Material: premium-quality polyester, water-repellent
- Recycled outer material: robust polyester fabric made from recycled PET bottles (twist material 50%), water-repellent

• **L'original : un modèle plébiscité et mondialement connu. Déjà un classique !**

- frame : cadre en aluminium stable et raffinement coloré
- Poignée rabattable avec revêtement souple
- 1 poche intérieure zippée
- Fond rigide avec pieds
- bavaria 6 : avec un motif créatif, des broderies et des ornements
- Accessoire en option : carrybag cover
- Résistant jusqu'à 20 kg
- Matière : polyester de haute qualité, déperlant
- Matière principale recyclé : robuste tissu polyester fabriqué à partir de bouteilles PET recyclées (twist matière 50%), déperlant

CARRYBAG® FRAME



BK 1036*
frame twist sky rose



BK 3076
frame mixed dots red



BK 3079*
frame signature sunset



BK 3083*
frame florist peach



BK 3085*
frame twist berry



BK 4073
frame signature navy



BK4083
frame bavaria 6



BK 4093*
frame florist lagoon



BK 4094*
frame florist indigo



BK 4097*
frame twist ocean



BK 4098*
frame twist azure



BK 6043*
frame twist coffee



BK 6044*
frame safari sand



BK 7040
frame black/black



BK 7041
frame gold/black



BK 7052
frame twist silver



BK 7054
frame signature black

CARRYBAG® XS



↳ 33,5 x 21 x 19,5 cm
□ 5 l

VE/UNIT 6/12

• **Das Original in XS – heiß begehrt, weltbekannt und schon heute ein Klassiker!**

- Stabiler Aluminiumrahmen
- Weich ummantelter Griff zum Umklappen
- 1 Innentasche mit Reißverschluss
- Fester Boden mit Standfüßen
- Belastbar bis 8 kg
- Material: hochwertiges Polyester-gewebe, wasserabweisend
- Recyceltes Obermaterial: robustes Polyestergewebe aus recycelten PET-Flaschen, wasserabweisend

• **The original XS: highly coveted, internationally known and already a classic today!**

- Sturdy aluminium frame
- Collapsible soft rubber handle
- 1 zip pocket inside
- Rigid bottom with base feet
- Loadable up to 8 kg
- Material: premium-quality polyester, water-repellent
- Recycled outer material: robust polyester fabric made from recycled PET bottles, water-repellent

• **L'original XS : un modèle plébiscité et mondialement connu. Déjà un classique !**

- Cadre stable en aluminium
- Poignée rabattable avec revêtement souple
- 1 poche intérieure zippée
- Fond rigide avec pieds
- Résistant jusqu'à 8 kg
- Matière : polyester de haute qualité, déperlant
- Matière principale recyclé : robuste tissu polyester fabriqué à partir de bouteilles PET recyclées, déperlant



BN 3075*
mixed dots red



BN 4059*
dark blue



BN 7003*
black



BN 7009*
dots

RE-SHOPPER 1

**BEST
SELLER**



↳ 56 x 32 x 24 cm
□ 25 l

VE/UNIT 4/12

• **Design, Funktion und Material perfekt kombiniert**

- Umweltschonende, robuste Tasche mit ultrapraktischer Aufteilung
- 4 Fächer innen für cleveres Verstauen und Transportieren
- 1 Reißverschlussfach und 2 Steckfächer innen
- Steckschlaufen und 1 Steckfach außen
- Trageriemen mit Griffpolster
- Breiter, leicht gepolsterter Boden für stabilen Stand
- Platzsparend zusammenfaltbar
- Recyceltes Obermaterial: robustes Polyestergewebe aus recycelten PET-Flaschen, wasserabweisend

• **Design, function and material, perfectly combined**

- Environmentally friendly, robust bag with ultra-practical design
- 4 compartments for clever storage and transport
- 1 zip pocket and 2 separate compartments on the inside
- 1 compartment and holders on the outside
- Carrying straps with grip handles
- Broad, lightly padded base for stability
- Can be folded together to save space
- Recycled outer material: robust polyester fabric made from recycled PET bottles, water-repellent

• **Un design, une fonctionnalité et une matière parfaitement combinés**

- Sac solide, qui respecte l'environnement avec une répartition ultra-pratique
- 4 compartiments pour un rangement bien pensé et un transport facile
- 1 poche zippée et 2 poches de rangement intérieures
- 1 poche de rangement et des passants à l'extérieur
- Anses avec poignées
- Fond large et légèrement rembourré pour une bonne stabilité
- Pliable et peu encombrant
- Matière principale recyclé : robuste tissu polyester fabriqué à partir de bouteilles PET recyclées, déperlant



DJ 3011
aubergine



DJ 4005
navy



DJ 7003
black

LOOPSHOPPER L



↳ 46 x 34,5 x 25 cm
 □ 25 l

VE/UNIT 4/12

• **Eleganz beim Einkaufen, viele Funktionen inklusive**

- Komfortabel gepolsterte Tragegriffe aus stabilem Aluminium
- frame: stabiler, farbig veredelter Aluminiumrahmen
- Über der Schulter und in der Hand zu tragen
- 1 Innentasche mit Reißverschluss
- 2 Stecktaschen außen
- Fester Boden mit Standfüßen
- rhombus black: modernes 3-D-Steppdesign
- Recyceltes Obermaterial: robustes Polyestergewebe aus recycelten PET-Flaschen (twist Material 50%), wasserabweisend

• **Elegant shopping with lots of extra functions included**

- Comfortably padded carrying handles made of strong aluminium
- frame: sturdy, colour-refined aluminium frame
- Can be carried over the shoulder or by hand
- 1 zip pocket inside
- 2 outside storage pockets
- Rigid bottom with base feet
- rhombus black: modern 3-D quilted design
- Recycled outer material: robust polyester fabric made from recycled PET bottles (twist material 50%), water-repellent

• **Faites votre shopping avec classe – nombreuses astuces pratiques**

- Poignées en aluminium rigides rembourrées pour un confort maximum
- frame : cadre en aluminium stable et raffinement coloré
- Peut également être porté à l'épaule
- 1 poche intérieure zippée
- 2 poches extérieures
- Fond rigide avec pieds
- rhombus black : motif matelassé moderne en 3D
- Matière principale recyclé : robuste tissu polyester fabriqué à partir de bouteilles PET recyclées (twist matière 50%), déperlant

LOOPSHOPPER L



LIMITED EDITION

OR 2031*
viola yellow



LIMITED EDITION

OR 3080*
viola mauve



OR 4027
twist blue



LIMITED EDITION

OR 4090*
viola celeste



LIMITED EDITION

OR 4091*
viola blue



OR 7059
rhombus black

LOOPSHOPPER L FRAME



OR 1036*
frame twist sky rose



OR 3076
frame mixed dots red



LIMITED EDITION

OR 3079*
frame signature sunset



LIMITED EDITION

OR 3083*
frame florist peach



OR 3085*
frame twist berry



OR 4073
frame signature navy



LIMITED EDITION

OR 4093*
frame florist lagoon



OR 4094*
frame florist indigo



LIMITED EDITION

OR 4097*
frame twist ocean



LIMITED EDITION

OR 4098*
frame twist azure



OR 6043*
frame twist coffee



LIMITED EDITION

OR 6044*
frame safari sand



OR 7040
frame black



OR 7052
frame twist silver



OR 7056
frame dots

EASYSHOPPINGBAG



↗ 32,5 x 38 x 51 cm
(36,5 x 6 x 6 cm)

☐ 30 l

VE/UNIT 6/24

• Durchdachte Taschenkonstruktion zum Zusammenrollen

- 2 stabile Einhängestangen für den Einkaufswagen
- Extrahülle zum Verstauen
- Öffnung durch Klettbinden verschließbar
- Trageriemen mit Griffpolster
- 1 Reißverschluss-Innentasche
- 2 Einkaufswagen-Chips im innen liegenden Druckknopf-Täschchen inklusive
- Material: hochwertiges Polyester-gewebe, wasserabweisend
- Recyceltes Obermaterial: robustes Polyestergewebe aus recycelten PET-Flaschen, wasserabweisend

• Sophisticated collapsible design

- 2 stable hanging bars for supermarket trolleys
- Extra cover bag for storage
- Opening can be shut with Velcro strips
- Carrying straps with grip handles
- 1 zip pocket inside
- 2 plastic trolley tokens in small inside pocket with press studs included
- Material: premium-quality polyester, water-repellent
- Recycled outer material: robust polyester fabric made from recycled PET bottles, water-repellent

• Design malin : peut être enroulé dans sa housse

- 2 barres de suspension robustes pour le chariot de courses
- Housse séparée pour le rangement
- Ouverture refermable par bandes velcros
- Anses avec poignées rembourrées jointes par des bandes velcros
- 1 poche intérieure zippée
- 2 jetons pour chariot de courses compris dans la petite poche intérieure à bouton-pression
- Matière : polyester de haute qualité, déperlant
- Matière principale recyclé : robuste tissu polyester fabriqué à partir de bouteilles PET recyclées, déperlant



UJ 3004
red



UJ 3070
signature red



UJ 3075
mixed dots red



UJ 4059
dark blue



UJ 7003
black



UJ 7009
dots



UJ 7054
signature black

BOTTLEBAG

**BEST
SELLER**



↳ 24 x 28 x 24 cm
 ↳ 9 x 0,75 l

VE/UNIT 10/40

• **Steckt literweise ein – und macht alle Wege ganz bequem**

- 2 reißfeste Trageriemen mit Klettband-Kopplung
- Bei Bedarf flach zusammenzulegen
- Das Bodenmaß ist auf handelsübliche Fahrradkörbe zugeschnitten
- Material: hochwertiges Polyester-gewebe, wasserabweisend
- Recyceltes Obermaterial: robustes Polyestergewebe aus recycelten PET-Flaschen (twist Material 50%), wasserabweisend

• **A bag for every bottle and maximum convenience**

- 2 tear-proof carrying straps joined by Velcro strips
- Folds flat if needed
- Bottom size corresponds to dimensions of standard bicycle baskets
- Material: premium-quality polyester, water-repellent
- Recycled outer material: robust polyester fabric made from recycled PET bottles (twist material 50%), water-repellent

• **Un compartiment pour chaque bouteille pour faciliter le transport**

- 2 bandoulières renforcées jointes par bandes velcros
- Pliable à plat si besoin
- Les dimensions du fond correspondent à celles d'un panier de vélo classique
- Matière : polyester de haute qualité, déperlant
- Matière principale recyclé : robuste tissu polyester fabriqué à partir de bouteilles PET recyclées (twist matière 50%), déperlant



ZJ 3004
red



ZJ 3070
signature
red



ZJ 3075
mixed dots
red



ZJ 4027
twist blue



ZJ 4073
signature
navy



ZJ 7003
black



ZJ 7009
dots



ZJ 7052
twist silver

SHOULDERBAG S



↳ 29 x 28,5 x 7,5 cm
 □ 4,7 l

VE/UNIT 6/24

• **Unkomplizierte kleine Umhängetasche**

- Breite, einfach zugängliche Reißverschlussöffnung
- Ins Innenfutter integrierte Reißverschlusstasche
- Verstellbarer Schultergurt
- Recyceltes Obermaterial: robustes Polyestergewebe aus recycelten PET-Flaschen (twist Material 50%), wasserabweisend

• **Straightforward small shoulder bag**

- Wide and easily accessible zip opening
- Zipped pocket integrated into the inner lining
- Adjustable shoulder strap
- Recycled outer material: robust polyester fabric made from recycled PET bottles (twist material 50%), water-repellent

• **Un petit sac à bandoulière tout en simplicité**

- Large ouverture zippée facile d'accès
- Poche intérieure zippée intégrée à la doublure
- Bandoulière réglable
- Matière principale recyclée: robuste tissu polyester fabriqué à partir de bouteilles PET recyclées (twist matière 50%), déperlant



LIMITED EDITION

HY 2031*
viola yellow



HY 3075
mixed dots red



LIMITED EDITION

HY 3080*
viola mauve



HY 4027
twist blue



HY 4073
signature navy



LIMITED EDITION

HY 4090*
viola celeste



LIMITED EDITION

HY 4091*
viola blue



HY 7003
black



HY 7009
dots



HY 7052
twist silver

SHOPPER XS

↳ 31 x 21 x 16 cm
□ 4 l

VE/UNIT 6/24

• **Die kleine Version des shopper M zum Umhängen**

- Öffnung mit Reißverschluss verschließbar
- 1 Innentasche mit Reißverschluss
- 2 kurze Tragehenkel, 1 längenverstellbarer Schultergurt
- Quadratischer Boden für festen Stand
- bavaria 5: mit hochwertiger Samtschleife
- bavaria 6: mit kreativem Print, Stickereien und Verzierungen
- Material: hochwertiges Polyestergewebe, wasserabweisend
- Recyceltes Obermaterial: robustes Polyestergewebe aus recycelten PET-Flaschen, wasserabweisend

• **The small version of shopper M to hang over the shoulder**

- Opening can be zipped shut
- 1 zip pocket inside
- 2 short carrying handles, 1 adjustable shoulder strap
- Square bottom for extra stability
- bavaria 5: with premium velvet bow
- bavaria 6: with creative print, embroidery and decorations
- Material: premium-quality polyester, water-repellent
- Recycled outer material: robust polyester fabric made from recycled PET bottles, water-repellent

• **Le shopper M en version mini à porter sur l'épaule**

- Ouverture refermable par une fermeture zippée
- 1 poche intérieure zippée
- 2 poignées, 1 bandoulière ajustable
- Fond carré pour une bonne stabilité
- bavaria 5 : avec un nœud en velours de haute qualité
- bavaria 6 : avec un motif créatif, des broderies et des ornements
- Matière : polyester de haute qualité, déperlant
- Matière principale recyclé : robuste tissu polyester fabriqué à partir de bouteilles PET recyclées, déperlant



ZR 3074
bavaria 5
dark ruby



ZR 3075
mixed dots
red



ZR 3078*
florist
peach



ZR 4073
signature
navy



ZR 4078
bavaria 5
blue



ZR 4079
bavaria 6



ZR 4087*
florist lagoon



ZR 4088*
florist indigo



ZR 7009
dots

SHOPPER M



↳ 51 x 30,5 x 26 cm
 □ 15 l

VE/UNIT 6/24

• **Einkaufen mit Funktionalität und Stil – ganz ohne Wenn und Aber**

- Öffnung mit Reißverschluss verschließbar
- 1 Innentasche mit Reißverschluss
- Quadratischer Boden für festen Stand
- Material: hochwertiges Polyester-gewebe, wasserabweisend
- Recyceltes Obermaterial: robustes Polyestergewebe aus recycelten PET-Flaschen (twist Material 50%), wasserabweisend

• **Shopping with efficiency and style: the practical shopping experience!**

- Opening can be zipped shut
- 1 zip pocket inside
- Square bottom for extra stability
- Material: premium-quality polyester, water-repellent
- Recycled outer material: robust polyester fabric made from recycled PET bottles (twist material 50%), water-repellent

• **Un sac fonctionnel et pratique, idéal pour le shopping !**

- Ouverture refermable par une fermeture zippée
- 1 poche intérieure zippée
- Fond carré pour une bonne stabilité
- Matière : polyester de haute qualité, déperlant
- Matière principale recyclé : robuste tissu polyester fabriqué à partir de bouteilles PET recyclées (twist matière 50%), déperlant

SHOPPER M



ZS 1035*
twist sky rose



ZS 2031*
viola yellow



ZS 3004
red



ZS 3070
signature red



ZS 3075
mixed dots red



ZS 3077*
twist berry



ZS 3078*
florist peach



ZS 3080*
viola mauve



ZS 3084*
signature sunset



ZS 4027
twist blue



ZS 4073
signature navy



ZS 4084*
twist azure



ZS 4086*
twist ocean



ZS 4087*
florist lagoon



ZS 4088*
florist indigo



ZS 4090*
viola celeste



ZS 4091*
viola blue



ZS 6041*
twist coffee



ZS 6042*
safari sand



ZS 7003
black



ZS 7009
dots



ZS 7052
twist silver



ZS 7054
signature black

SHOPPER e1

**BEST
SELLER**



- ↳ 50 x 26,5 x 16,5 cm (normal)
- 50 x 35 x 16,5 cm (expanded/déplié)
- ☐ 12 l (normal)
- 18 l (expanded/déplié)

VE/UNIT 6/24

• **Platz für den kleinen und den großen Einkauf**

- Öffnung mit Reißverschluss verschließbar
- 2 kurze Trageriemen
- Seitlich umlaufender Reißverschluss vergrößert durch Öffnen das Volumen der Tasche
- 1 Innentasche mit Reißverschluss
- Material: hochwertiges Polyester-gewebe, wasserabweisend
- Recyceltes Obermaterial: robustes Polyestergewebe aus recycelten PET-Flaschen (twist Material 50%), wasserabweisend

• **Space for small and big purchases**

- Opening can be zipped shut
- 2 short carrying handles
- Lateral zip increases bag volume when opened
- 1 zip pocket inside
- Material: premium-quality polyester, water-repellent
- Recycled outer material: robust polyester fabric made from recycled PET bottles (twist material 50%), water-repellent

• **De la place pour les petits et les gros achats**

- Ouverture refermable par une fermeture zippée
- 2 anses courtes
- L'ouverture du zip placé sur le pourtour du sac permet d'augmenter son volume
- 1 poche intérieure zippée
- Matière : polyester de haute qualité, déperlant
- Matière principale recyclé : robuste tissu polyester fabriqué à partir de bouteilles PET recyclées (twist matière 50%), déperlant

SHOPPER e1



RJ 1035*
twist sky rose



RJ 2031*
viola yellow



RJ 3070
signature red



RJ 3075
mixed dots red



RJ 3077*
twist berry



RJ 3078*
florist peach



RJ 3080*
viola mauve



RJ 3084*
signature sunset



RJ 4027
twist blue



RJ 4073
signature navy



RJ 4084*
twist azure



RJ 4086*
twist ocean



RJ 4087*
florist lagoon



RJ 4088*
florist indigo



RJ 4090*
viola celeste



RJ 4091*
viola blue



RJ 6041*
twist coffee



RJ 6042*
safari sand



RJ 7003
black



RJ 7009
dots



RJ 7052
twist silver



RJ 7054
signature black

SHOPPER XL



↳ 68 x 45,5 x 20 cm

□ 35 l

VE/UNIT 6/12

• **Der grundsolide Vielzweckbegleiter für Freizeit und Shopping**

- 2 stabile Trageriemen mit Karabinerhaken
- Öffnung mit Reißverschluss über die volle Breite
- 1 Innentasche mit Reißverschluss
- Stecktasche fürs Mobiltelefon
- Material: hochwertiges Polyestergewebe, wasserabweisend
- Recyceltes Obermaterial: robustes Polyestergewebe aus recycelten PET-Flaschen (twist Material 50%), wasserabweisend

• **Respectable multipurpose companion for leisure and shopping**

- 2 sturdy carrying straps with snap hooks
- Zip all the way across the opening
- 1 zip pocket inside
- Mobile phone pocket
- Material: premium-quality polyester, water-repellent
- Recycled outer material: robust polyester fabric made from recycled PET bottles (twist material 50%), water-repellent

• **Le sac multi-usages, solide et résistant. Idéal pour vos virées shopping et vos loisirs**

- 2 anses solides avec mousquetons
- Ouverture avec fermeture zippée sur toute la largeur
- 1 poche intérieure zippée
- Poche de rangement pour téléphone portable
- Matière : polyester de haute qualité, déperlant
- Matière principale recyclé : robuste tissu polyester fabriqué à partir de bouteilles PET recyclées (twist matière 50%), déperlant

SHOPPER XL



ZU 1035*
twist sky rose



ZU 2031*
viola yellow



ZU 3070
signature red



ZU 3075
mixed dots red



ZU 3077*
twist berry



ZU 3078*
florist peach



ZU 3080*
viola mauve



ZU 3084*
signature sunset



ZU 4027
twist blue



ZU 4073
signature navy



ZU 4084*
twist azure



ZU 4086*
twist ocean



ZU 4087*
florist lagoon



ZU 4088*
florist indigo



ZU 4090*
viola celeste



ZU 4091*
viola blue



ZU 6041*
twist coffee



ZU 6042*
safari sand



ZU 7003
black



ZU 7009
dots



ZU 7052
twist silver



ZU 7054
signature black

CARRYCRUISER®

**BEST
SELLER**



↳ 42 x 47,5 x 32 cm

□ 40 l

VE/UNIT 1/1



#FORM
2007



• **Das Multitalent, mit dem alle großen Einkäufe richtig in Fahrt kommen**

- Stabiler Aluminiumrahmen
- frame: stabiler, farbig veredelter Aluminiumrahmen
- Herausnehmbares, waschbares Innenfutter mit Zugverschluss
- Herausnehmbare Netz-Innentasche
- Verstellbarer Schultergurt mit Schulterpolster
- 2-fach ausziehbare Teleskopstange
- Große, leicht laufende, kugelgelagerte Räder
- Standfüße aus Kunststoff
- Clip-Halterungen zum Befestigen am Einkaufswagen
- 2 Einkaufswagen-Chips
- rhombus black: modernes 3-D-Steppdesign
- Optionales Zubehör: carrycruiser cover
- Maximale Griffhöhe: 94 cm
- Belastbar bis 20 kg
- Material: hochwertiges Polyester-gewebe, wasserabweisend
- Recyceltes Obermaterial: robustes Polyestergewebe aus recycelten PET-Flaschen (twist Material 50%), wasserabweisend

• **This one does it all for you on extensive shopping trips**

- Stable aluminium frame
- frame: sturdy, colour-refined aluminium frame
- Removable, washable lining with toggle fastener
- Removable mesh inner pocket
- Adjustable, padded shoulder strap
- 2-stage telescopic handle
- Large, smooth-turning wheels with ball bearings
- Plastic base feet
- Fixtures for attaching to supermarket trolleys
- 2 supermarket trolley tokens
- rhombus black: modern 3-D quilted design
- Optional accessory: carrycruiser cover
- Maximum handle height: 94 cm
- Loadable up to 20 kg
- Material: premium-quality polyester, water-repellent
- Recycled outer material: robust polyester fabric made from recycled PET bottles (twist material 50%), water-repellent

• **Un cabas aux talents multiples pour répondre à tous vos besoins lors des courses**

- Cadre stable en aluminium
- frame : cadre en aluminium stable et raffinement coloré
- Doublure intérieure amovible, lavable, avec cordon de serrage
- Pochette intérieure en filet amovible
- Bretelle de transport rembourrée et réglable
- Poignée télescopique rétractable en 2 temps
- Grandes roues à roulements à billes silencieuses et très maniables
- 2 pieds en plastique
- Supports à clips pour fixation au chariot de courses
- 2 jetons pour chariot de courses
- rhombus black : motif matelassé moderne en 3D
- Accessoire en option : carrycruiser cover
- Hauteur maximale de la poignée : 94 cm
- Résistant jusqu'à 20 kg
- Matière : polyester de haute qualité, déperlant
- Matière principale recyclé : robuste tissu polyester fabriqué à partir de bouteilles PET recyclées (twist matière 50%), déperlant

CARRYCRUISER®



OE 3004
red



OE 4027
twist blue



OE 4059
dark blue



OE 7003
black



OE 7009
dots



OE 7027
baroque taupe



OE 7059
rhombus black

CARRYCRUISER® FRAME



OE 1036*
frame twist sky rose



OE 3076
frame mixed dots red



OE 3085*
frame twist berry



OE 4073
frame signature navy



OE 4081
frame mixed dots blue



OE 4094*
frame florist indigo



OE 6043*
frame twist coffee



OE 7040
frame black/black



OE 7052
frame twist silver



OE 7054
frame signature black

CARRYCRUISER® COVER

↙ ↘ 42 x 8 x 33,5 cm

VE/UNIT 4/24



OG 7003
black

CARRYCRUISER® PLUS



↳ 42 X 52,5 X 32 cm

☐ 46 l

VE/UNIT 1/1

• Der Klassiker mit mehr Platz und mehr Funktion

- Großes, bei Bedarf ausfaltbares Thermofach vorne mit Innenfutter aus hochwertiger Aluminiumfolie, abwaschbar
- Deckel mit 2-Wege-Reißverschluss und griffigen Logo-Pullern
- Angenehm tragbar mit gepolstertem Schultergurt
- Stabiler Aluminiumrahmen
- carrycruiser frame: stabiler, farbig veredelter Aluminiumrahmen
- Herausnehmbare Netz-Innentasche
- Passt sich Ihrer Größe an – dank 3-fach ausziehbarer Teleskopstange
- Maximale Griffhöhe: 105 cm
- Große, leicht laufende, kugelgelagerte Räder
- Standfüße aus Kunststoff
- Praktische Clip-Halterungen für den Einkaufswagen
- 2 Einkaufswagen-Chips
- Belastbar bis 20 kg
- Recyceltes Obermaterial: robustes Polyestergewebe aus recycelten PET-Flaschen (twist Material 50%), wasserabweisend

• The classic with more space and more features

- Large thermal compartment at the front, which can be folded out if necessary, with an inner lining made of high-quality aluminum foil, washable
- Lid with 2-way zip and easy-to-grip logo pullers
- Comfortable to carry with a padded shoulder strap
- Stable aluminum frame
- carrycruiser frame: sturdy, colour-refined aluminium frame
- Removable inner mesh pocket
- Adapts to your size – thanks to 3-stage telescopic rod
- Maximum handle height: 105 cm
- Large, smooth-turning wheels with ball bearings
- Plastic feet
- Practical clip fixtures for attaching to supermarket trolleys
- 2 shopping supermarket trolley tokens
- Loadable up to 20 kg
- Recycled outer material: robust polyester fabric made from recycled PET bottles (twist material 50%), water-repellent

• Le classique pour plus de place et plus de fonctionnalités

- Grand compartiment isotherme N325, qui peut être déplié si nécessaire, avec une doublure intérieure en feuille d'aluminium de haute qualité, lavable
- Couvercle avec fermeture zippée à double sens et des tirettes-logos faciles à saisir
- Agréable à porter avec sa bandoulière rembourrée à l'épaule
- Cadre stable en aluminium
- carrycruiser frame : cadre en aluminium stable et raffinement coloré
- Pochette intérieure filet amovible
- S'adapte à votre taille grâce à son manche télescopique réglable en 3 temps
- Hauteur maximale de la poignée : 105 cm
- Grandes roues à roulements à billes très maniables
- Pieds en plastique
- Clips de fixation au chariot de courses super pratiques
- 2 jetons pour chariot de courses
- Résistant jusqu'à 20 kg
- Matière principale recyclé : robuste tissu polyester fabriqué à partir de bouteilles PET recyclées (twist matière 50%), déperlant

CARRYCRUISER® PLUS



OF 7009
dots

CARRYCRUISER® PLUS FRAME



OF 4073
frame signature navy



OF 7040
frame black



OF 7052
frame twist silver

CITYCRUISER RACK

4X
Click!



↳ 47,5 x 105,5 x 39 cm
 🛒 25 kg

VE/UNIT 1/1

• **Kombiniere das citycruiser rack mit einem der bags zu dem idealen Einkaufstrolley**

- Mehrfachnutzen durch stabile Bodenplatte
- Mit Reflektoren zur Sicherheit
- Platzsparend zusammenklappbar
- 4-fach höhenverstellbarer Teleskopgriff
- Große, leicht laufende, 2-fach kugelgelagerte Räder, abnehmbar
- Halterung zum Befestigen am Einkaufswagen
- Zusätzliche Halterung zum Einhängen von Einkaufstaschen
- Belastbar bis 25 kg
- Auch für den Transport von Getränkekästen o. Ä. geeignet
- Maximale Griffhöhe: 105,5 cm
- Material: Eisen, Polypropylen, EVA (Räder)

• **Combine the citycruiser rack with one of the citycruiser bags to create the ideal shopping trolley**

- Multiple advantages owing to the stable base plate
- With reflectors for your safety
- Collapsible for space-saving
- 4 x height-adjustable telescopic handle
- Large, smooth-turning twin ball-bearing wheels, detachable
- Fixtures for attaching to supermarket trolley
- Additional holder to hook in shopping bags
- Loading capacity 25 kg
- Suitable for transporting crates of beverages and similar
- Maximum handle height: 105,5 cm
- Material: iron, polypropylene, EVA (wheels)

• **Combinez le citycruiser rack avec l'un des sacs et obtenez le chariot idéal**

- De multiples avantages grâce à une plaque de fond solide
- Équipé de réflecteurs pour plus de sécurité
- Pliable pour un encombrement minimum
- Poignée télescopique à hauteur réglable en quatre temps
- Grandes roues maniables avec double roulement à billes, détachables
- Support pour fixation au chariot de supermarché
- Crochet supplémentaire pour suspendre d'autres sacs de courses
- Résistant jusqu'à 25 kg
- Adapté au transport de caisses à bouteilles entre autres
- Hauteur maximale de la poignée : 105,5 cm
- Matière : fer, polypropylène, EVA (roues)



DE 7003
black

CITYCRUISER BAG



↕ 34 x 60 x 24 cm
 □ 45 l

VE/UNIT 1/6

• Durchdacht bis ins letzte Detail

- Das Rack ist im Lieferumfang nicht enthalten und muss extra bestellt werden
- Großes, mit Reißverschluss teilbares Hauptfach
- 2 große, separate Öffnungen mit Reißverschluss
- Abnehmbarer Schultergurt
- Seitliche Außentasche sowie Innentasche mit Reißverschluss
- Zusätzliche Front-Stecktasche
- Seitlicher Schirmhalter
- Belastbar bis 20 kg
- Recyceltes Obermaterial: robustes Polyestergewebe aus recycelten PET-Flaschen (twist Material 50%), wasserabweisend

• Well thought out down to the last detail

- Rack is not included and must be ordered separately
- Large main compartment, detachable using a zip
- 2 large, separate zipped openings
- Detachable shoulder strap
- Lateral outer pocket and zipped inner pocket
- Additional front pocket
- Lateral umbrella holder
- Loading capacity 20 kg
- Recycled outer material: robust polyester fabric made from recycled PET bottles (twist material 50%), water-repellent

• Pensé dans les moindres détails

- Le rack n'est pas inclus dans la livraison et doit être commandé séparément
- Grand compartiment principal séparable à l'aide d'une fermeture zippée
- 2 grandes ouvertures séparées avec fermeture zippée
- Bandoulière amovible
- Poche latérale extérieure et poche intérieure avec fermeture zippée
- Poche de rangement frontale supplémentaire
- Résistant jusqu'à 20 kg
- Matière principale recyclé : robuste tissu polyester fabriqué à partir de bouteilles PET recyclées (twist matière 50%), déperlant



DF 3075
mixed dots red



DF 4027
twist blue



DF 4073
signature navy



DF 7003
black



DF 7009
dots



DF 7052
twist silver

TROLLEY M

↳ 43 x 53 x 21 cm
 □ 43 l

VE/UNIT 2/2

• Der geräumige, flexible und praktische Shopping-Trolley

- Mit zusätzlichem Stauraum durch Hochstellen der Verschlussklappe
- Komfortabler Transport auf 2 sanft laufenden Rollen
- 2-fach höhenverstellbare Aluminium-Teleskopstange, verschwindet hinter einem Reißverschluss
- trolley M frame: stabiler, farbig veredelter Aluminiumrahmen
- 1 Reißverschlussfach auf der Rückseite
- Maximale Griffhöhe: 98 cm
- Belastbar bis 15 kg
- Material: hochwertiges Polyestergewebe, wasserabweisend
- Recyceltes Obermaterial: robustes Polyestergewebe aus recycelten PET-Flaschen, wasserabweisend

• The spacious, flexible and practical shopping trolley

- Additional storage space by raising the flap
- Comfortable transport on 2 near-effortless rollers
- 2-stage aluminium telescopic handle tucks away behind a zipper
- trolley M frame: sturdy, colour-refined aluminium frame
- 1 zip pocket on the back
- Maximum handle height: 98 cm
- Loadable up to 15 kg
- Material: premium-quality polyester, water-repellent
- Recycled outer material: robust polyester fabric made from recycled PET bottles, water-repellent

• Le trolley grande capacité, flexible et pratique

- Espace de rangement supplémentaire en soulevant le rabat
- Transport aisé grâce aux 2 roues facilement manœuvrables
- Poignée télescopique rétractable en deux temps cachée derrière une fermeture zippée
- trolley M frame : cadre en aluminium stable et raffinement coloré
- 1 poche zippée au dos
- Hauteur maximale de la poignée : 98 cm
- Résistant jusqu'à 15 kg
- Matière : polyester de haute qualité, déperlant
- Matière principale recyclée : robuste tissu polyester fabriqué à partir de bouteilles PET recyclées, déperlant



NT 3076
frame
mixed dots red



NT 4027
twist blue



NT 4073
frame
signature navy



NT 7003
black



NT 7009
dots



NT 7027
baroque taupe



NT 7052
twist silver



NT 7054
frame
signature black

FOLDABLE TROLLEY

↳ 29 x 66 x 27 cm
(32,5 x 25 x 6,5 cm)
□ 30 l

VE/UNIT 6/12

• **3-fach gefaltet, dann ganz einfach verpackt – ein wahrer Wunderrolley!**

- Hauptfach mit Druckknopf verschließbar
- Kopplung der Zughenkel mit Klett-Handgriff
- Stabiler Kantenschutz an der unteren Rückwand
- Feste, formstabile Bodenplatte
- Belastbar bis 10 kg
- Maximale Griffhöhe: 85 cm
- Material: hochwertiges Polyester-gewebe, wasserabweisend
- Recyceltes Obermaterial: robustes Polyestergewebe aus recycelten PET-Flaschen, wasserabweisend

• **Foldable 3 ways for easy storage: a true miracle worker!**

- Main compartment closed with press stud
- Pulling handles are joined by Velcro hand grip
- Sturdy edge protection on bottom backboard
- Firm, dimensionally stable base plate
- Loadable up to 10 kg
- Maximum handle height: 85 cm
- Material: premium-quality polyester, water-repellent
- Recycled outer material: robust polyester fabric made from recycled PET bottles, water-repellent

• **Pliable en trois pour un rangement aisé : un super trolley !**

- Compartiment principal à qui se ferme par bouton-pression
- Poignées jointes par bande velcro
- Protection rigide sur le bord inférieur de la paroi arrière
- Plaque de fond solide et indéformable
- Résistant jusqu'à 10 kg
- Hauteur maximale de la poignée : 85 cm
- Matière : polyester de haute qualité, déperlant
- Matière principale recyclé : robuste tissu polyester fabriqué à partir de bouteilles PET recyclées, déperlant



HK 3004
red



HK 3075
mixed dots red



HK 7003
black



HK 7009
dots



HK 7027
baroque taupe

RHOMBUS BLACK

SHOPPER-BACKPACK

↳ 45 x 44 x 17 cm

□ 16 l

VE/UNIT 2/12

• **Stylisher Stadtrucksack und Tasche in einem für Arbeit oder Freizeit**

- Entspricht den vorgeschriebenen Maßen für Handgepäck
- Modernes 3-D-Steppdesign
- Geräumige V-Form: Hauptfach mit 2-Wege-Reißverschluss, passend für 15,6"-Laptop
- 1 Reißverschlussfach außen und innen
- Verstellbare, gepolsterte Schultergurte
- 2 zusätzliche Tragehenkel
- Fester Stand durch rechteckigen Boden
- Recyceltes Obermaterial: robustes Polyestergewebe aus recycelten PET-Flaschen, wasserabweisend

• **Stylish city backpack and bag in one for work or leisure**

- Matches the prescribed dimensions for hand luggage
- Modern 3-D quilted design
- Spacious V-shape: Main compartment with 2-way zip, fits 15.6" laptop
- 1 zipped compartment outside and inside
- Adjustable, padded shoulder straps
- 2 additional carrying handles
- Stable due to rectangular base
- Recycled outer material: robust polyester fabric made from recycled PET bottles, water-repellent

• **Sac à dos urbain et élégant ou sac tout-en-un pour le travail comme pour les loisirs**

- Conforme aux dimensions prescrites pour les bagages à main
- Motif matelassé moderne en 3-D
- Forme en V pour une grande contenance : Compartiment principal avec fermeture zippée à double sens, convient à un ordinateur portable de 15,6"
- 1 compartiment zippé à l'extérieur et à l'intérieur
- Bretelles réglables et rembourrées
- 2 poignées de transport supplémentaires
- Stable grâce à sa base rectangulaire
- Matière principale recyclé : robuste tissu polyester fabriqué à partir de bouteilles PET recyclées, déperlant



BJ 7059*
shopper-backpack



CLASSIC SHOPPER M

↳ 40 x 35 x 13 cm

□ 8 l

VE/UNIT 4/12

• **Cleverer Shopper mit nützlichen Details für den Alltag und für abends**

- Modernes 3-D-Steppdesign
- Hauptfach mit Zugverschluss
- 1 Reißverschlussfach außen und innen
- 2 Tragehenkel
- Fester Stand durch rechteckigen Boden
- Recyceltes Obermaterial: robustes Polyestergewebe aus recycelten PET-Flaschen, wasserabweisend

• **Clever bag with useful details for everyday use and evening**

- Modern 3-D quilted design
- Main compartment with drawstring closure
- 1 zipped compartment outside and inside
- 2 carrying straps
- Rectangular base for stability
- Recycled outer material: robust polyester fabric made from recycled PET bottles, water-repellent

• **Un shopper astucieux avec des détails pratiques pour un usage en journée comme en soirée**

- Motif matelassé moderne en 3-D
- Compartiment principal avec fermeture à cordon
- 1 compartiment zippé à l'extérieur et à l'intérieur
- 2 sangles de transport
- Stable grâce à sa base rectangulaire
- Matière principale recyclé : robuste tissu polyester fabriqué à partir de bouteilles PET recyclées, déperlant



DH 7059*
classic shopper M



RHOMBUS BLACK

CLASSIC SHOPPER L

↳ 39 x 28 x 16 cm

☐ 12 l

VE/UNIT 4/12

- **Stilvolle Schultertasche für jeden Tag mit viel Platz und praktischen Details**
 - Modernes 3-D-Steppdesign
 - 2 Hauptfächer und mittiges Reißverschlussfach
 - Verschlusslasche mit Druckknopf
 - Format durch seitliche Druckknöpfe anpassbar
 - 1 Reißverschlussfach innen
 - 2 Tragehenkel
 - Fester Stand durch rechteckigen Boden
 - Recyceltes Obermaterial: robustes Polyestergewebe aus recycelten PET-Flaschen, wasserabweisend
- **Stylish shoulder bag for every day with plenty of space and practical details**
 - Modern 3-D quilted design
 - 2 main compartments and central zipped compartment
 - Closure flap with snap fastener
 - Size can be adjusted with snap fastener at the side
 - 1 zipped compartment inside
 - 2 carrying straps
 - Rectangular base for stability
 - Recycled outer material: robust polyester fabric made from recycled PET bottles, water-repellent
- **Un sac à bandoulière élégant pour tous les jours, avec beaucoup de place et des détails astucieux**
 - Motif matelassé moderne en 3-D
 - 2 compartiments principaux et un compartiment central zippé
 - Rabat de fermeture avec bouton pression
 - La taille peut être ajustée grâce à des boutons pression latéraux
 - 1 compartiment zippé à l'intérieur
 - 2 sangles de transport
 - Stable grâce à sa base rectangulaire
 - Matière principale recyclé : robuste tissu polyester fabriqué à partir de bouteilles PET recyclées, déperlant



DK 7059*
classic shopper L

CLASSIC SHOPPER XL

↳ 62 x 36 x 22 cm

☐ 26 l

VE/UNIT 4/12

- **Extragroße Tasche für Strand, Shopping und Supermarkt**
 - Modernes 3-D-Steppdesign
 - Format kann durch Druckknopf Flasche angepasst werden: V-Form oder rechteckig
 - Großes Hauptfach mit Druckknopfverschluss
 - 1 Reißverschlussfach innen
 - 2 Tragehenkel und 2 zusätzliche Schultergurte
 - Fester Stand durch rechteckigen Boden
 - Recyceltes Obermaterial: robustes Polyestergewebe aus recycelten PET-Flaschen, wasserabweisend
- **Extra-large bag for the beach, shopping and supermarket**
 - Modern 3-D quilted design
 - Format can be adjusted by snap fastener V-shaped or rectangular
 - Large main compartment with snap fastener
 - 1 zipped compartment inside
 - 2 carrying handles and 2 additional shoulder straps
 - Stable due to rectangular base
 - Recycled outer material: robust polyester fabric made from recycled PET bottles, water-repellent
- **Sac extra-large pour la plage, le shopping et le supermarché**
 - Motif matelassé moderne en 3-D
 - La forme en V ou rectangulaire peut être ajustée avec le rabat à bouton-pression
 - Grand compartiment principal avec fermeture à bouton pression
 - 1 compartiment zippé à l'intérieur
 - 2 poignées de transport et 2 bretelles supplémentaires
 - Stable grâce à sa base rectangulaire
 - Matière principale recyclé : robuste tissu polyester fabriqué à partir de bouteilles PET recyclées, déperlant



DL 7059*
classic shopper XL



THERMO



CARRYCRUISER ISO	52
CARRYBAG ISO	53
THERMOCASE	54
COOLERBAG XS	55
COOLERBAG S POCKET	56
COOLERBAG M POCKET	57
COOLERBAG	58
COOLERBAG XL	60
COOLER-BACKPACK	61
THERMOSHOPPER	62
COOLER-BOTTLEBAG	63

THERMO

CARRYCRUISER® ISO



↳ 42 x 47,5 x 32 cm
 □ 40 l
 ❄ insulated

VE/UNIT 1/1



• Der carrycruiser mit Kühlfunktion

- Isolierende Innenfolie und dicht schließender Deckel mit Reißverschluss
- Stabiler Aluminiumrahmen
- carrycruiser® iso frame: stabiler, farbig veredelter Aluminiumrahmen
- Herausnehmbare Netz-Innentasche
- Verstellbarer Schultergurt mit Schulterpolster
- 2-fach ausziehbare Teleskopstange
- Große, leicht laufende, kugelgelagerte Räder
- Standfüße aus Kunststoff
- Clip-Halterungen zum Befestigen am Einkaufswagen
- 2 Einkaufswagen-Chip
- Maximale Griffhöhe: 94 cm
- Belastbar bis 20 kg
- Material: hochwertiges Polyester-gewebe, wasserabweisend
- Recyceltes Obermaterial: robustes Polyestergewebe aus recycelten PET-Flaschen, wasserabweisend

• The carrycruiser with cooling function

- Insulating inner lining and tight-fitting lid with zip
- Stable aluminium frame
- carrycruiser® iso frame: sturdy, colour-refined aluminium frame
- Removable mesh inner pocket
- Adjustable, padded shoulder strap
- 2-stage telescopic handle
- Large, smooth-turning wheels with ball bearings
- Plastic base feet
- Fixtures for attaching to supermarket trolley
- 2 supermarket trolley tokens
- Maximum handle height: 94 cm
- Loadable up to 20 kg
- Material: premium-quality polyester, water-repellent
- Recycled outer material: robust polyester fabric made from recycled PET bottles, water-repellent

• Le carrycruiser avec fonction isotherme

- Film intérieur isotherme et couvercle hermétique avec fermeture éclair
- Cadre stable en aluminium
- carrycruiser® iso frame : cadre en aluminium stable et raffinement coloré
- Pochette intérieure en filet amovible
- Bretelle de transport rembourrée et ajustable
- Poignée télescopique rétractable en 2 temps
- Grandes roues à roulements à billes, silencieuses et très maniables
- 2 pieds en plastique
- Supports à clips pour fixation au chariot de courses
- 2 jetons pour chariot de courses
- Hauteur maximale de la poignée : 94 cm
- Résistant jusqu'à 20 kg
- Matière : polyester de haute qualité, déperlant
- Matière principale recyclé : robuste tissu polyester fabriqué à partir de bouteilles PET recyclées, déperlant



OJ 3004
red



OJ 7003
black



OJ 7052
frame twist silver



THERMO

CARRYBAG® ISO



↳ 48 x 29 x 28 cm

□ 22 l

✱ insulated

VE/UNIT 4/12

Design Award 2004
DESIGN PLUS

Focus Know-how
Silber 2005



• Der carrybag mit Kühlfunktion

- Isolierende Innenfolie und dicht schließender Deckel mit Reißverschluss
- Stabiler Aluminiumrahmen
- carrybag® iso frame: stabiler, farbig veredelter Aluminiumrahmen
- Weich ummantelter Griff zum Umklappen
- 1 Innentasche mit Reißverschluss
- Fester Boden mit Standfüßen
- Bei Bedarf flach zusammenzulegen
- Material: hochwertiges Polyester-gewebe, wasserabweisend
- Belastbar bis 20 kg
- Recyceltes Obermaterial: robustes Polyestergewebe aus recycelten PET-Flaschen (twist Material 50%), wasserabweisend

• The carrybag with cooling function

- Insulating inner lining and tight-fitting lid with zip
- Sturdy aluminium frame
- carrybag® iso frame: sturdy, colour-refined aluminium frame
- Collapsible soft rubber handle
- 1 zip pocket inside
- Rigid bottom with base feet
- Folds flat if needed
- Material: premium-quality polyester, water-repellent
- Loadable up to 20 kg
- Recycled outer material: robust polyester fabric made from recycled PET bottles (twist material 50%), water-repellent

• Le carrybag avec fonction isotherme

- Film intérieur isotherme et couvercle hermétique avec fermeture à glissière
- Cadre stable en aluminium
- carrybag® iso frame : cadre en aluminium stable et raffinement coloré
- Poignée rabattable avec revêtement souple
- 1 poche intérieure zippée
- Fond rigide avec pieds
- Pliable à plat si besoin
- Matière : polyester de haute qualité, déperlant
- Résistant jusqu'à 20 kg
- Matière principale recyclé : robuste tissu polyester fabriqué à partir de bouteilles PET recyclées (twist matière 50%), déperlant



BT 3004
red



BT 7003
black



BT 7052
frame twist silver

THERMO

THERMOCASE

**BEST
SELLER**



↳ 20 x 14 x 6,5 cm

□ 1,5 l

✳ insulated

VE/UNIT 4/24

• **Perfekter kleiner Alltags- und Reisebegleiter**

- Isoliertes Etui für alles, was vor Wärme geschützt werden soll
- Thermo-Innenfutter aus hochwertiger Aluminiumfolie
- Dicht schließender Deckel mit Reißverschluss
- Netzfach innen
- 1 Tragegriff
- Material: hochwertiges Polyester-gewebe, wasserabweisend
- Recyceltes Obermaterial: robustes Polyestergewebe aus recycelten PET-Flaschen (twist Material 50%), wasserabweisend

• **The perfect little companion for everyday use and travel**

- Insulated case for anything that should be kept cool
- Thermal lining made of high-quality aluminium foil
- Tight-fitting lid with zip
- Inner mesh pocket
- 1 carrying handle
- Material: premium-quality polyester, water-repellent
- Recycled outer material: robust polyester fabric made from recycled PET bottles (twist material 50%), water-repellent

• **Le petit accessoire parfait au quotidien et en voyage**

- Étui isotherme pour conserver les aliments à l'abri de la chaleur
- Doublure isotherme en feuille d'aluminium haut de gamme
- Abattant hermétique avec fermeture zippée
- Compartiment filet à l'intérieur
- 1 poignée
- Matière : polyester de haute qualité, déperlant
- Matière principale recyclée : robuste tissu polyester fabriqué à partir de bouteilles PET recyclées (twist matière 50%), déperlant



OY 3004
red

OY 3075
mixed dots red

OY 4027
twist blue

OY 7003
black

OY 7009
dots

OY 7052
twist silver

THERMO

COOLERBAG XS



↳ 27,5 x 15,5 x 12 cm

□ 4 l

✱ insulated

VE/UNIT 4/24

• **Smart to go: die kleine coolerbag – perfekt für den carrybag XS!**

- Die kleine Version der coolerbag
- Für Mittagessen oder Picknick
- Thermo-Innenfutter aus hochwertiger Aluminiumfolie
- Dicht schließender Deckel mit 2-Wege-Reißverschluss
- 2 Tragehenkel
- Material: hochwertiges Polyester-gewebe, wasserabweisend
- Recyceltes Obermaterial: robustes Polyestergewebe aus recycelten PET-Flaschen (twist Material 50%), wasserabweisend

• **Smart to go: the small coolerbag – perfect for our carrybag XS!**

- The small version of the coolerbag
- For lunches and picnics
- Thermal lining made of high-quality aluminium foil
- Tight-fitting lid with 2-way zip
- 2 carrying straps
- Material: premium-quality polyester, water-repellent
- Recycled outer material: robust polyester fabric made from recycled PET bottles (twist material 50%), water-repellent

• **Pour emporter son repas partout : le petit coolerbag astucieux – parfait pour le carrybag XS**

- Le modèle réduit du coolerbag
- Pour le déjeuner ou un pique-nique
- Doublure isotherme en feuille d'aluminium haut de gamme
- Abattant hermétique avec fermeture zippée à double sens
- 2 lanières
- Matière : polyester de haute qualité, déperlant
- Matière principale recyclé : robuste tissu polyester fabriqué à partir de bouteilles PET recyclées (twist matière 50%), déperlant



UF 3004
red



UF 3075
mixed dots red



UF 4027
twist blue



UF 7003
black



UF 7009
dots



UF 7052
twist silver

THERMO

COOLERBAG S POCKET



↳ 22,5 x 12 x 18,5 cm

□ 2,5 l

✱ insulated

VE/UNIT 4/24

• **Die ideale Tasche für Lunch, Snacks oder ergänzend beim Einkauf**

- Thermo-Innenfutter aus hochwertiger Aluminiumfolie, pflegeleichte Reinigung
- Dicht schließender Deckel mit 2-Wege-Reißverschluss
- Tragegriff auf dem Deckel
- thermo pop: Tragegriff aus leuchtendem 6-farbigem Band
- Recyceltes Obermaterial: robustes Polyestergewebe aus recycelten PET-Flaschen (twist material 50%), wasserabweisend

• **The ideal bag for lunch, snacks or when shopping**

- Thermal lining made of high-quality aluminium foil, easy-care cleaning
- Tight-fitting lid with 2-way zip
- Handle on the lid
- thermo pop: vibrant 6-coloured woven strap handle
- Recycled outer material: robust polyester fabric made from recycled PET bottles (twist material 50%), water-repellent

• **Le sac idéal pour le déjeuner, les collations ou pour les courses**

- Doublure isotherme en feuille d'aluminium de haute qualité, nettoyage facile
- Couvercle à fermeture hermétique avec fermeture éclair bidirectionnelle
- Poignée sur le couvercle
- thermo pop : poignée aux 6 couleurs vives
- Matière principale recyclé : robuste tissu polyester fabriqué à partir de bouteilles PET recyclées (twist matière 50%), déperlant



LG 2032*
pop lemon

LIMITED EDITION



LG 3070
signature red



LG 3075
mixed dots red



LG 3081*
pop mandarin

LIMITED EDITION



LG 3082*
pop strawberry

LIMITED EDITION



LG 4005
navy



LG 4027
twist blue



LG 4073
signature navy



LG 4085*
pop pool

LIMITED EDITION



LG 7003
black



LG 7009
dots



LG 7052
twist silver

THERMO

COOLERBAG M POCKET



↳ 28 x 12 x 22,5 cm

□ 4,5 l

※ insulated

VE/UNIT 4/24

• **Die ideale Tasche für Lunch, Snacks oder ergänzend beim Einkauf**

- Thermo-Innenfutter aus hochwertiger Aluminiumfolie, pflegeleichte Reinigung
- Dicht schließender Deckel mit 2-Wege-Reißverschluss
- Tragegriff auf dem Deckel
- thermo pop: Tragegriff aus leuchtendem 6-farbigem Band
- Recyceltes Obermaterial: robustes Polyestergewebe aus recycelten PET-Flaschen (twist Material 50%), wasserabweisend

• **The ideal bag for lunch, snacks or when shopping**

- Thermal lining made of high-quality aluminium foil, easy-care cleaning
- Tight-fitting lid with 2-way zip
- Handle on the lid
- thermo pop: vibrant 6-coloured woven strap handle
- Recycled outer material: robust polyester fabric made from recycled PET bottles (twist material 50%), water-repellent

• **Le sac idéal pour le déjeuner, les collations ou pour les courses**

- Doublure isotherme en feuille d'aluminium de haute qualité, nettoyage facile
- Couvercle à fermeture hermétique avec fermeture éclair bidirectionnelle
- Poignée sur le couvercle
- thermo pop : poignée aux 6 couleurs vives
- Matière principale recyclé : robuste tissu polyester fabriqué à partir de bouteilles PET recyclées (twist matière 50%), déperlant



LF 2032*
pop lemon



LF 3070
signature red



LF 3075
mixed dots red



LF 3081*
pop mandarin



LF 3082*
pop strawberry



LF 4005
navy



LF 4027
twist blue



LF 4073
signature navy



LF 4085*
pop pool



LF 7003
black



LF 7009
dots



LF 7052
twist silver

THERMO

COOLERBAG

**BEST
SELLER**



↳ 44,5 x 24,5 x 25 cm

☐ 20 l

✳ insulated

VE/UNIT 4/12

• **Füreinander gemacht, die maßgeschneiderte Ergänzung zum carrybag**

- Sehr dicke Isolierung für höhere Kühlleistung
- Dicht schließender Deckel mit 2-Wege-Reißverschluss
- Thermo-Innenfutter aus hochwertiger Aluminiumfolie, pflegeleichte Handhabung
- 2 Tragehenkel
- thermo pop: 2 weiche Trageriemen aus leuchtendem 6-farbigem Band
- Stabiler, widerstandsfähiger Boden
- Material: hochwertiges Polyester-gewebe, wasserabweisend
- Recyceltes Obermaterial: robustes Polyestergewebe aus recycelten PET-Flaschen (twist Material 50%), wasserabweisend

• **Made for each other, the made-to-measure complement to the carrybag**

- Very thick insulation provides excellent cooling performance
- Tight-fitting lid featuring a 2-way zip
- Thermal lining made of high-quality aluminium foil; low maintenance
- 2 carrying handles
- thermo pop: 2 soft and vibrant 6-coloured woven strap handles
- Sturdy, hard-wearing base
- Material: premium-quality polyester, water-repellent
- Recycled outer material: robust polyester fabric made from recycled PET bottles (twist material 50%), water-repellent

• **Faits l'un pour l'autre : le complément sur mesure pour le carrybag**

- Isolation très épaisse pour une capacité de refroidissement optimale
- Abattant hermétique avec fermeture zippée à double sens
- Doublure isotherme en feuille d'aluminium haut de gamme facile d'entretien
- 2 anses
- thermo pop : 2 poignées souples aux 6 couleurs vives
- Fond stable et résistant
- Matière : polyester de haute qualité, déperlant
- Matière principale recyclé : robuste tissu polyester fabriqué à partir de bouteilles PET recyclées (twist matière 50%), déperlant

COOLERBAG



UH 1035*
twist sky rose



UH 2032*
pop lemon



UH 3004
red



UH 3075
mixed dots red



UH 3081*
pop mandarin



UH 3082*
pop strawberry



UH 4027
twist blue



UH 4073
signature navy



UH 4085*
pop pool



UH 4088*
florist indigo



UH 7003
black



UH 7009
dots



UH 7052
twist silver



UH 7054
signature black

THERMO

COOLERBAG XL



↳ 37 x 41 x 26 cm

□ 30 l

✳ insulated

VE/UNIT 1/6

- **Extragroße Thermotasche für Einkauf, Picknick und Strand**
- Passt perfekt in den Carrycruiser
- Dicke Isolierung für hohe Kühlleistung
- Dicht schließender Deckel mit 2-Wege-Reißverschluss
- Fester EVA-Deckel kann als Picknicktisch genutzt werden, mit 2 Mulden für Becher oder Tassen
- Thermo-Innenfutter aus hochwertiger Aluminiumfolie, pflegeleichte Reinigung
- 2 Tragehenkel
- 1 Steckfach außen
- Recyceltes Obermaterial: robustes Polyestergewebe aus recycelten PET-Flaschen (twist Material 50%), wasserabweisend

- **Extra-large thermal bag for shopping, picnics and the beach**
- Fits perfectly into the carrycruiser
- Thick insulation for high cooling performance
- Tight-fitting lid with 2-way zip
- Solid EVA lid can be used as a picnic table, with 2 holders for mugs or cups
- Thermal lining made of high-quality aluminium foil, easy-care cleaning
- 2 handle straps
- 1 outside pocket
- Recycled outer material: robust polyester fabric made from recycled PET bottles (twist material 50%), water-repellent

- **Très grand sac isotherme pour le shopping, les pique-niques et la plage**
- S'intègre parfaitement dans le carrycruiser
- Isolation épaisse pour une performance de réfrigération optimale
- Couverture hermétique avec fermeture éclair bidirectionnelle
- Le couvercle rigide (en matière EVA) peut être utilisé comme table de pique-nique, avec 2 compartiments pour gobelets ou tasses
- Doublure isotherme en feuille d'aluminium de haute qualité, nettoyage facile
- 2 anses
- 1 poche extérieure
- Matière principale recyclée: robuste tissu polyester fabriqué à partir de bouteilles PET recyclées (twist matière 50%), déperlant



LH 3070
signature red



LH 3075
mixed dots red



LH 4005
navy



LH 4073
signature navy



LH 7003
black



LH 7009
dots



LH 7052
twist silver

THERMO

COOLER-BACKPACK



↳ 43 x 43 x 14 cm
□ 18 l

VE/UNIT 4/24

• Coole Thermo-Tragetasche und lässiger Rucksack in einem

- Großes, geräumiges Innenfach
- Thermo-Innenfutter aus hochwertiger Aluminiumfolie, pflegeleichte Reinigung
- Große Reißverschlussöffnung
- 1 Außenfach mit Reißverschluss
- 2 Trageriemen, auf der Rückseite verstellbar für Rucksackfunktion
- Recyceltes Obermaterial: robustes Polyestergewebe aus recycelten PET-Flaschen (twist Material 50%), wasserabweisend

• Cool thermal tote bag and casual backpack in one

- Large, spacious inner compartment
- Thermal lining made of high-quality aluminium foil, easy-care cleaning
- Large zip opening
- 1 outer compartment with zip
- 2 handles, adjustable on the back for backpack function
- Recycled outer material: robust polyester fabric made from recycled PET bottles (twist material 50%), water-repellent

• À la fois sac isotherme stylé et sac à dos décontracté

- Grand compartiment intérieur spacieux
- Doublure isotherme en feuille d'aluminium de haute qualité, nettoyage facile
- Grande ouverture zippée
- 1 compartiment extérieur avec fermeture éclair
- 2 poignées réglables à l'arrière pour la fonction sac à dos
- Matière principale recyclé : robuste tissu polyester fabriqué à partir de bouteilles PET recyclées (twist matière 50%), déperlant



LJ 3070
signature red



LJ 3075
mixed dots red



LJ 4005
navy



LJ 4027
twist blue



LJ 4073
signature navy



LJ 7003
black



LJ 7009
dots



LJ 7052
twist silver

THERMO

THERMOSHOPPER

**BEST
SELLER**

COOL BAG
KÜHLTASCHE

↕ 38 x 35 x 16 cm

☐ 15 l

✳ insulated

VE/UNIT 4/12

• Idealer Begleiter für den Einkauf oder das Picknick

- Thermo-Innenfutter aus hochwertiger Aluminiumfolie
- Dicht schließender Deckel mit 2-Wege-Reißverschluss
- 1 Stecktasche außen
- 2 Trageriemen
- thermo pop: 2 weiche Trageriemen aus leuchtendem 6-farbigem Band
- Material: hochwertiges Polyester-gewebe, wasserabweisend
- Recyceltes Obermaterial: robustes Polyester-gewebe aus recycelten PET-Flaschen (twist Material 50%), wasserabweisend

• The ideal companion for shopping and picnics

- Thermal lining made of high-quality aluminium foil
- Tight-fitting lid with 2-way zip
- 1 outer pocket
- 2 carrying straps
- thermo pop: 2 soft and vibrant 6-coloured woven strap handles
- Material: premium-quality polyester, water-repellent
- Recycled outer material: robust polyester fabric made from recycled PET bottles (twist material 50%), water-repellent

• Le compagnon idéal pour les courses ou le pique-nique

- Doublure isotherme en feuille d'aluminium haut de gamme
- Abattant hermétique avec fermeture zippée à double sens
- 1 poche de rangement extérieure
- 2 lanières
- thermo pop : 2 poignées souples aux 6 couleurs vives
- Matière : polyester de haute qualité, déperlant
- Matière principale recyclé : robuste tissu polyester fabriqué à partir de bouteilles PET recyclées (twist matière 50%), déperlant



OV 1035*
twist sky rose



OV 2032*
pop lemon



OV 3004
red



OV 3075
mixed dots red



OV 3081*
pop mandarin



OV 3082*
pop strawberry



OV 4027
twist blue



OV 4073
signature navy



OV 4085*
pop pool



OV 7003
black



OV 7009
dots



OV 7052
twist silver

THERMO

COOLER-BOTTLEBAG



↳ 10 x 26,5 x 10 cm

☐ Max. 1 l

VE/UNIT 4/24

• **So bleibt im Sommer jedes Getränk frisch**

- Thermohülle für Getränkeflasche
- Sicherer Stand durch leichte Polsterung
- Seitlich angebrachter Griff
- Thermo-Innenfutter aus hochwertiger Aluminiumfolie, pflegeleichte Reinigung
- Recyceltes Obermaterial: robustes Polyestergewebe aus recycelten PET-Flaschen, wasserabweisend

• **Keeps every drink cool in summer**

- Thermal cover for beverage bottle
- Sturdy stand thanks to light padding
- Handle attached to the side
- Thermal lining made of high-quality aluminium foil, easy-care cleaning
- Recycled outer material: robust polyester fabric made from recycled PET bottles, water-repellent

• **Pour que chaque boisson reste fraîche en été**

- Housse isotherme pour bouteille
- Bonne stabilité grâce à un rembourrage léger
- Poignée positionnée latéralement
- Doublure isotherme en feuille d'aluminium de haute qualité, nettoyage facile
- Matière principale recyclé : robuste tissu polyester fabriqué à partir de bouteilles PET recyclées, déperlant



LK 4005
navy



LK 7003
black



MINI MAXI

MINI MAXI RUCKSACK	66
MINI MAXI SHOPPER PLUS	67
MINI MAXI SHOPPER	68
MINI MAXI SHOPPER DISPLAY	70
MINI MAXI SHOPPER POCKET	72
MINI MAXI SHOPPER L	73
MINI MAXI TOURINGBAG	74
MINI MAXI PONCHO	75

MINI MAXI

MINI MAXI RUCKSACK

**BEST
SELLER**



↳ 30 x 45 x 11 cm (16 x 23 x 2 cm)
29,5 x 20 x 41 cm (display)

☐ 14 l

🌀 machine wash cold

VE/UNIT 4/48

VE/UNIT 24/48 (display)

• **Allzeit bereit, um jedes Transportproblem auf die leichte Schulter zu nehmen**

- In eigener Außentasche kompakt zu verpacken
- Hauptfach mit Reißverschluss
- Zusätzlicher Tragehenkel zwischen den Schultergurten
- Material: hochwertiges Polyester-gewebe, wasserabweisend
- Recyceltes Obermaterial: robustes Polyestergewebe aus recycelten PET-Flaschen, wasserabweisend

• **Always ready to shoulder your load**

- Can be folded up compactly and stowed away in its own outside pocket
- Main compartment can be zipped shut
- Additional carrying handle between the shoulder straps
- Material: high-quality polyester, water-repellent
- Recycled outer material: robust polyester fabric made from recycled PET bottles, water-repellent

• **Toujours prêt à vous épauler !**

- Rangement compact dans sa propre poche extérieure
- Compartiment principal avec fermeture zippée
- Poignée supplémentaire entre les bretelles
- Matière : polyester de haute qualité, déperlant
- Matière principale recyclé : robuste tissu polyester fabriqué à partir de bouteilles PET recyclées, déperlant



AP 3075
mixed dots red



AP 4073
signature navy



AP 7003
black



AP 7009
dots



AP 7027
baroque taupe



AP 7054
signature black

MINI MAXI SHOPPER PLUS



↳ 42,5 x 60 x 7 cm
 ☐ 20 l
 🔄 machine wash cold

VE/UNIT 12/120

• **Beliebtes mini maxi Modell mit mehr Funktionen**

- 3 zusätzliche Steckfächer außen
- Winzig klein zusammenzulegen und mit flexiblem Band zu fixieren
- 2 lange Tragehenkel, auch als Schultergurte zu verwenden
- Material: hochwertiges Polyester-gewebe, wasserabweisend
- Recyceltes Obermaterial: robustes Polyestergewebe aus recycelten PET-Flaschen, wasserabweisend

• **Popular mini maxi model with more functions**

- 3 additional pockets on the outside
- Folds to mini size and is fixed with a flexible band
- 2 long handles also function as shoulder straps
- Material: high-quality polyester, water-repellent
- Recycled outer material: robust polyester fabric made from recycled PET bottles, water-repellent

• **Incontournable modèle mini maxi avec plus de fonctionnalités**

- 3 poches supplémentaires à l'extérieur
- Minuscule une fois plié et bloqué grâce à un élastique
- 2 longues anses, peut également être porté à l'épaule
- Matière : polyester de haute qualité, déperlant
- Matière principale recyclé : robuste tissu polyester fabriqué à partir de bouteilles PET recyclées, déperlant

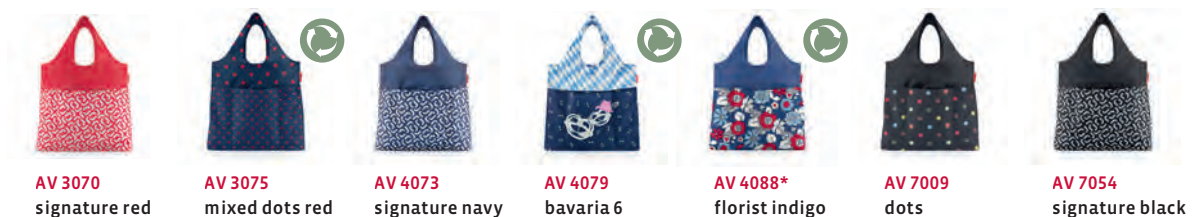

AV 3070
signature red

AV 3075
mixed dots red

AV 4073
signature navy

AV 4079
bavaria 6

AV 4088*
florist indigo

AV 7009
dots

AV 7054
signature black

MINI MAXI

MINI MAXI SHOPPER

**BEST
SELLER**



↳ 43,5 x 63 x 6 cm (6 x 12 x 2 cm)

☐ 15 l

🔄 machine wash cold

VE/UNIT 12/120

• **mini maxi shopper in attraktiven Designs**

- Winzig klein zusammenzulegen und mit flexiblem Band zu fixieren
- 2 lange Tragehenkel, auch als Schultergurte zu verwenden
- Material: hochwertiges Polyester-gewebe, wasserabweisend
- Recyceltes Obermaterial: robustes Polyestergewebe aus recycelten PET-Flaschen, wasserabweisend

• **mini maxi shopper in attractive patterns**

- Folds to mini size and is fixed with a flexible band
- 2 long carrying handles which double as shoulder straps
- Material: premium-quality polyester, water-repellent
- Recycled outer material: robust polyester fabric made from recycled PET bottles, water-repellent

• **mini maxi shopper avec de nouveaux motifs attrayants**

- Minuscule une fois plié, maintenu grâce à un élastique
- 2 longues anses pouvant être portées à l'épaule
- Matière : polyester de haute qualité, déperlant
- Matière principale recyclé : robuste tissu polyester fabriqué à partir de bouteilles PET recyclées, déperlant

MINI MAXI SHOPPER



AT 2031*
viola yellow



AT 3004
red



AT 3070
signature red



AT 3074
bavaria 5 dark ruby



AT 3075
mixed dots red



AT 3078*
florist peach



AT 3080*
viola mauve



AT 3084*
signature sunset



AT 4054
french blue



AT 4059
dark blue



AT 4073
signature navy



AT 4078
bavaria 5 blue



AT 4079
bavaria 6



AT 4087*
florist lagoon



AT 4088*
florist indigo



AT 4090*
viola celeste



AT 4091*
viola blue



AT 6042*
safari sand



AT 7003
black



AT 7009
dots



AT 7027
baroque taupe



AT 7054
signature black

How to fold from *maxi* to *mini*

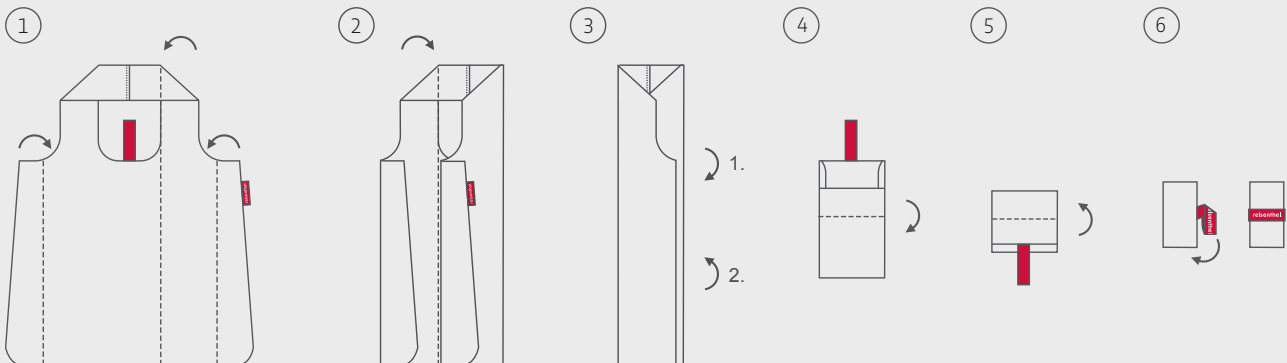

MINI MAXI

MINI MAXI SHOPPER DISPLAY

**BEST
SELLER**



↳ 33,5 x 13 x 20,5 cm

VE/UNIT 48/192



AT 0002
mini maxi shopper
display unicolour
48 pcs (8 pcs per design)



AT 0027
mini maxi shopper
collection #23 dots
48 pcs (8 pcs per design)





AT 0031
 mini maxi shopper
 collection #27 city
 48 pcs (8 pcs per design)



AT 0035
 mini maxi shopper
 collection #31 signature
 48 pcs (3 x 8 pcs per design,
 2 x 12 pcs per design)



AT 0036
 mini maxi shopper
 collection #32 florist
 48 pcs (4 x 8 pcs per design,
 1 x 16 pcs florist indigo)



* Ausliefertermin: 03/2022 | Delivery date: 03/2022 | Date de livraison : 03/2022



AV 0001
 mini maxi shopper plus
 collection #1 bicolor
 48 pcs (12 pcs per design)



* Ausliefertermin: 03/2022 | Delivery date: 03/2022 | Date de livraison : 03/2022

MINI MAXI SHOPPER POCKET



↳ 45 x 53,5 x 7 cm (5 x 10,5 x 2 cm)
29,5 x 14 x 41 cm (display)

- ☐ 15 l
- 🔄 machine wash cold

VE/UNIT 12/120
VE/UNIT 80/240 (display)

• **Das Original – viel Volumen bei winzigem Packmaß**

- Stets einsatzbereit und umweltfreundlicher als jede Plastiktüte
- In separatem Etui kompakt zu verpacken
- 2 Tragehenkel
- Material: hochwertiges Polyester-gewebe, wasserabweisend

• **The original: huge capacity folded into a tiny package**

- Always on hand and better for the environment than any plastic bag
- Can be packed into separate pouch
- 2 carrying handles
- Material: premium-quality polyester, water-repellent

• **L'original : une contenance énorme dans une housse minuscule**

- Toujours à portée de main et tellement plus respectueux de l'environnement qu'un sac en plastique !
- À plier de manière compacte dans l'étui séparé
- 2 anses
- Matière : polyester de haute qualité, déperlant



AO 0058
mini maxi shopper pocket display
* Single units available



AO 2023*
banana cream



AO 2024*
autumn glory



AO 3004*
red



AO 4054*
french blue



AO 4055*
damson



AO 5036*
spectra green



AO 7003*
black



AO 7043*
basalt

MINI MAXI SHOPPER L



↳ 44 x 68 x 9 cm (6,5 x 13 cm)
39 x 14 x 32 cm (display)

☐ 22 l

🔄 machine wash cold

VE/UNIT 6/72

VE/UNIT 30/120 (display)

• Auf vielfachen Wunsch wieder mit an Bord: der Immer-dabei-Einkaufsbeutel

- Mit mehr Volumen, aus Ripstop-Material
- Stets einsatzbereit und umweltfreundlicher als jede Plastiktüte
- In separatem Etui kompakt zu verpacken
- 2 lange Tragehenkel, auch als Schultergurte zu verwenden
- Material: hochwertiges Polyester-gewebe, wasserabweisend

• Due to great demand, the always-on hand shopping bag is once again available

- Now in a larger size and made of rip-stop material
- Always ready for use and more environmentally friendly than a plastic bag
- Fits neatly into a separate carrying pouch
- 2 long carrying handles which double as shoulder straps
- Material: premium-quality polyester, water-repellent

• De retour suite à de nombreuses demandes : le sac de courses à avoir toujours sur soi

- Plus de volume, en matière ripstop
- Toujours prêt à l'emploi et plus respectueux de l'environnement que les sacs en plastique
- Prend peu de place une fois plié dans la housse séparée
- 2 anses longues pouvant être portées à l'épaule
- Matière : polyester de haute qualité, déperlant



AX 0002

mini maxi shopper L display

30 pcs (5 pcs per design)

* Single units available



AX 3004*
red



AX 4054*
french blue



AX 7003*
black



MINI MAXI TOURINGBAG

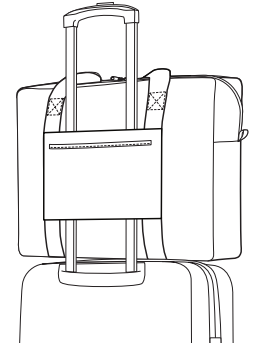

↳ 47,5 x 40 x 20 cm (22 x 16 x 3 cm)
29,5 x 20 x 41 cm (display)

☐ 40 l

🌀 machine wash cold

VE/UNIT 4/48

VE/UNIT 20/40 (display)

• **Der perfekte Reisebegleiter**

- In der Innentasche kompakt zu verpacken
- 2-Wege-Reißverschluss
- Tragehenkel lassen sich mit gepolsterter Schulterauflage koppeln
- Außentasche mit Reißverschluss vorne
- Trolley-Aufsteckfunktion
- Material: hochwertiges Polyester-gewebe, wasserabweisend
- Recyceltes Obermaterial: robustes Polyestergewebe aus recycelten PET-Flaschen, wasserabweisend

• **The perfect travel companion**

- Fits compactly into its inside pocket
- 2-way zip
- Handles can be connected with padded shoulder support
- Front outside pocket with zip
- Sleeve for attaching to a trolley suitcase
- Material: premium-quality polyester, water-repellent
- Recycled outer material: robust polyester fabric made from recycled PET bottles, water-repellent

• **L'accessoire de voyage parfait**

- Prend peu de place une fois plié dans la poche intérieure
- Fermeture zippée à double sens
- Un support d'épaule rembourré permet de réunir les anses
- Poche extérieure avec fermeture zippée à l'avant
- Sangle pour le glisser sur une valise à roulettes
- Matière : polyester de haute qualité, déperlant
- Matière principale recyclé : robuste tissu polyester fabriqué à partir de bouteilles PET recyclées, déperlant



AD 0056
mini maxi touringbag display
* Not included in the display



AD 3075*
mixed dots red



AD 4059
dark blue



AD 4073*
signature navy



AD 7003
black



AD 7009
dots



AD 7054*
signature black

MINI MAXI PONCHO



↳ 141 x 93 cm (15 x 21 x 3 cm)
29,5 x 20 x 41 cm (display)

VE/UNIT 6/24
VE/UNIT 24/48 (display)

- Nimmt kaum Platz in Anspruch, hält aber jedem Platzregen stand
- In der eigenen Brusttasche auf kleinstes Format zu verpacken
- Unter den Armen jeweils 2 Druckknöpfe
- Weite Kragenöffnung zum leichten An- und Ausziehen
- Einheitsgröße
- Material: hochwertiges Polyester-gewebe, wasserabweisend
- Recyceltes Obermaterial: robustes Polyestergewebe aus recycelten PET-Flaschen, wasserabweisend

- Takes up minimal room, yet offers maximum protection from downpours
- Can be folded to minimum size and stowed in its own breast pocket
- 2 press studs under each arm
- Wide collar opening makes it easy to put on and take off
- One size fits all
- Material: premium-quality polyester, water-repellent
- Recycled outer material: robust polyester fabric made from recycled PET bottles, water-repellent

- Protège des averses sans prendre de place
- Se fait tout petit dans sa propre poche poitrine
- 2 boutons-pression sous chaque bras
- Large ouverture de col pour l'enfiler et l'enlever plus facilement
- Taille unique
- Matière : polyester de haute qualité, déperlant
- Matière principale recyclé : robuste tissu polyester fabriqué à partir de bouteilles PET recyclées, déperlant



AN 0058
mini maxi poncho display
* Not included in the display



COSMETIC

CASE 1	78
MULTICASE	79
TRAVELCOSMETIC	80
DUOCASE	81
TOILETBAG	82
TOILETBAG XL	83
WRAPCOSMETIC	84
COSMETICPOUCH M	85

CASE 1



↳ 24 x 17 cm
VE/UNIT 12/48

• **Universeller Ordnungshelfer für Kosmetik und alle Kleinigkeiten in der Handtasche**

- Reißverschlussöffnung mit extralanger Zughilfe
- Innenfutter
- Material: hochwertiges Polyester-gewebe, wasserabweisend
- Recyceltes Obermaterial: robustes Polyestergewebe aus recycelten PET-Flaschen, wasserabweisend

• **All-purpose organiser for cosmetics and other small handbag items**

- Zip opening with extra-long pull tab
- Inner lining
- Material: premium-quality polyester, water-repellent
- Recycled outer material: robust polyester fabric made from recycled PET bottles, water-repellent

• **Pochette de rangement universelle pour sac à main destinée aux produits cosmétiques et petits accessoires**

- Fermeture zippée avec tirette extralongue
- Doublure
- Matière : polyester de haute qualité, déperlant
- Matière principale recyclé : robuste tissu polyester fabriqué à partir de bouteilles PET recyclées, déperlant



LR 3075
mixed dots red



LR 4027
twist blue



LR 4073
signature navy



LR 4088*
florist indigo



LR 7003
black



LR 7009
dots



LR 7052
twist silver



LR 7054
signature black



LR 7059*
rhombus black

MULTICASE



↳ 21 x 10 x 7 cm

□ 1,5 l

VE/UNIT 6/36

- **Farbenfroh und vielfach kombinierbar für Schule, Schönheit und Büro**
- Hauptfach mit Reißverschluss
- 1 flaches Reißverschlussfach innen
- 2 Steckfächer innen
- Material: hochwertiges Polyester-gewebe, wasserabweisend
- Recyceltes Obermaterial: robustes Polyestergewebe aus recycelten PET-Flaschen (twist Material 50%), wasserabweisend

- **Colourful and infinitely useful for school, office and beauty routines**
- Zipped main compartment
- 1 flat inside pocket with zip
- 2 inside pockets
- Material: premium-quality polyester, water-repellent
- Recycled outer material: robust polyester fabric made from recycled PET bottles (twist material 50%), water-repellent

- **Colorée et multi-usages : idéale pour les produits cosmétiques et les fournitures scolaires ou de bureau**
- Compartiment principal zippé
- 1 compartiment intérieur plat zippé
- 2 compartiments intérieurs
- Matière : polyester de haute qualité, déperlant
- Matière principale recyclé : robuste tissu polyester fabriqué à partir de bouteilles PET recyclées (twist matière 50%), déperlant



WJ 3070
signature red



WJ 3075
mixed dots red



WJ 4027
twist blue



WJ 4073
signature navy



WJ 4088*
florist indigo



WJ 7003
black



WJ 7009
dots



WJ 7027
baroque taupe



WJ 7052
twist silver



WJ 7054
signature black

TRAVELCOSMETIC



↳ 26 x 18 x 13,5 cm
 □ 4 l

VE/UNIT 6/24

• Stabil und komfortabel dank eingearbeiteter Metallbügel

- 3 Schlaufen an der Innenwand
- 1 Reißverschluss-Innentasche
- Handschlaufe
- Material: hochwertiges Polyester-gewebe, wasserabweisend
- Recyceltes Obermaterial: robustes Polyestergewebe aus recycelten PET-Flaschen (twist Material 50%), wasserabweisend

• Stable and convenient thanks to integrated metal braces

- 3 loops inside
- 1 zip pocket inside
- Hand strap
- Material: premium-quality polyester, water-repellent
- Recycled outer material: robust polyester fabric made from recycled PET bottles (twist material 50%), water-repellent

• Solide et pratique grâce à son armature intégrée en métal

- 3 élastiques de maintien sur la paroi intérieure
- 1 pochette intérieure zippée
- Dragonne
- Matière : polyester de haute qualité, déperlant
- Matière principale recyclé : robuste tissu polyester fabriqué à partir de bouteilles PET recyclées (twist matière 50%), déperlant

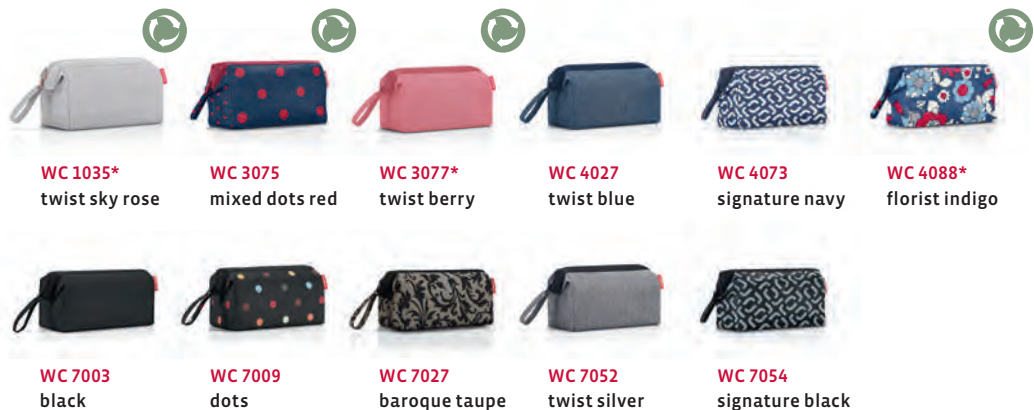

WC 1035*
twist sky rose

WC 3075
mixed dots red

WC 3077*
twist berry

WC 4027
twist blue

WC 4073
signature navy

WC 4088*
florist indigo

WC 7003
black

WC 7009
dots

WC 7027
baroque taupe

WC 7052
twist silver

WC 7054
signature black

DUOCASE



↳ 26 x 12,5 x 10 cm
 □ 3 l

VE/UNIT 6/24

• **Alles doppelt im Griff – auf Reisen, in der Schule oder im Büro**

- Geräumiges Etui mit 2 großen Hauptfächern
- Seitlicher Tragegriff
- 1 Reißverschlussfach und 2 Steckfächer innen
- Obermaterial: hochwertiges, recyceltes Polyestergewebe, wasserabweisend
- Recyceltes Obermaterial: robustes Polyestergewebe aus recycelten PET-Flaschen (twist Material 50%), wasserabweisend

• **Everything under control – when travelling, at school or in the office**

- Spacious case with 2 large main compartments
- Side handle
- 1 zip compartment and 2 open pockets inside
- Outer material: high-quality recycled polyester, water-repellent
- Recycled outer material: robust polyester fabric made from recycled PET bottles (twist material 50%), water-repellent

• **Tout est sous contrôle – en voyage, à l'école ou au bureau**

- Étui spacieux avec 2 grands compartiments principaux
- Poignée latérale
- 1 compartiment zippé et 2 poches ouvertes à l'intérieur
- Matière principale : polyester recyclé de haute qualité, déperlant
- Matière principale recyclé : robuste tissu polyester fabriqué à partir de bouteilles PET recyclées (twist matière 50%), déperlant



WA 4005
navy



WA 4027
twist blue



WA 4073
signature navy



WA 7003
black



WA 7009
dots



WA 7052
twist silver

TOILETBAG

**BEST
SELLER**



↳ 23 x 20 x 10 cm
(23 x 55 x 10 cm)

☐ 3 l

VE/UNIT 6/36

• **Aufklappen und aufhängen – an allen Plätzen zu Hause und auf Reisen!**

- 1 großes Hauptfach aus Netzmaterial mit 4 zusätzlichen Stecktaschen
- 2 Reißverschlusstaschen im Deckel
- Haken zum Aufhängen
- Spiegel kann innen mit Klettverschluss angeheftet werden
- Material: hochwertiges Polyester-gewebe, wasserabweisend
- Recyceltes Obermaterial: robustes Polyestergewebe aus recycelten PET-Flaschen (twist Material 50%), wasserabweisend

• **Just open and hang it up anywhere: at home or on the road!**

- 1 large main compartment with 4 additional pockets
- 2 zip pockets in the cover
- Suspension hook
- Mirror can be attached to the inside with Velcro
- Material: premium-quality polyester, water-repellent
- Recycled outer material: robust polyester fabric made from recycled PET bottles (twist material 50%), water-repellent

• **Il suffit de l'ouvrir pour pouvoir l'accrocher, à la maison comme en voyage !**

- 1 compartiment principal en filet avec 4 compartiments additionnels
- 2 poches zippées dans le rabat
- Crochet de suspension
- Le miroir peut être fixé à l'intérieur avec une bande auto-agrippante
- Matière : polyester de haute qualité, déperlant
- Matière principale recyclé : robuste tissu polyester fabriqué à partir de bouteilles PET recyclées (twist matière 50%), déperlant



WH 3004
red



WH 3075
mixed dots red



WH 4027
twist blue



WH 4073
signature navy



WH 7003
black



WH 7009
dots



WH 7027
baroque taupe



WH 7052
twist silver



WH 7054
signature black

TOILETBAG XL

**BEST
SELLER**



↗ 28 x 23 x 10 cm
(28 x 60 x 10 cm)

☐ 4 l

VE/UNIT 6/24

• Großzügige Kulturtasche für viel Komfort auf langen Reisen

- 1 geräumiges Hauptfach aus Netzmaterial mit 4 zusätzlichen Stecktaschen
- Zusätzliches Netzfach mit Reißverschluss auf der Front
- 3 Reißverschlusstaschen im Deckel
- Haken zum Aufhängen
- Spiegel kann innen mit Klettverschluss angeheftet werden
- Material: hochwertiges Polyestergewebe, wasserabweisend
- Recyceltes Obermaterial: robustes Polyestergewebe aus recycelten PET-Flaschen (twist Material 50%), wasserabweisend

• Spacious toiletry bag that is extremely convenient on long trips

- 1 large main compartment with 4 additional pockets
- Additional mesh pocket with zip on the front
- 3 zip pockets on the lid
- Suspension hook
- Mirror can be attached inside with Velcro
- Material: premium-quality polyester, water-repellent
- Recycled outer material: robust polyester fabric made from recycled PET bottles (twist material 50%), water-repellent

• Trousse de toilette grand volume pour un confort maximum lors des longs voyages

- 1 grand compartiment principal en filet et 4 pochettes additionnelles
- Compartiment en filet zippé sur le devant
- 3 poches zippées sous le rabat
- Crochet de suspension
- Possibilité de choisir la position du miroir grâce à une bande auto-agrippante
- Matière : polyester de haute qualité, déperlant
- Matière principale recyclé : robuste tissu polyester fabriqué à partir de bouteilles PET recyclées (twist matière 50%), déperlant



WO 3075
mixed dots red



WO 4027
twist blue



WO 4073
signature navy



WO 4080
mixed dots blue



WO 4088*
florist indigo



WO 6041*
twist coffee



WO 7003
black



WO 7009
dots



WO 7027
baroque taupe



WO 7052
twist silver



WO 7054
signature black

WRAPCOSMETIC



↳ 26 x 16 x 10 cm
(26 x 54 x 10 cm)

☐ 31

VE/UNIT 6/12

• **Moderne Kosmetiktasche zum Aufhängen**

- Zum Aufrollen und Aufhängen, praktisch und platzsparend
- 3 Reißverschlussfächer + 1 Netzfach mit Reißverschluss innen
- 2 Steckfächer
- 2 elastische Schlaufen
- Extrabreiter Spiegel innen kann mit Klettverschluss angeheftet werden
- Formstabil und schützend durch verstärkten Körper
- Recyceltes Obermaterial: robustes Polyestergewebe aus recycelten PET-Flaschen (twist Material 50%), wasserabweisend

• **Modern cosmetic bag for hanging**

- Can be rolled up and hung up, practical and space-saving
- 3 zip compartments + 1 mesh compartment with zip inside
- 2 open pockets
- 2 elastic loops
- Extra-wide mirror inside can be attached with Velcro
- Dimensionally stable and protective thanks to the reinforced body
- Recycled outer material: robust polyester fabric made from recycled PET bottles (twist material 50%), water-repellent

• **Trousse de toilette moderne à suspendre**

- S'enroule et s'accroche, pratique et peu encombrante
- 3 compartiments zippés + 1 compartiment intérieur en filet avec zip
- 2 poches ouvertes
- 2 boucles élastiques
- Le miroir extralarge à l'intérieur peut être attaché avec du velcro
- Stabilité dimensionnelle et protection grâce au corps renforcé
- Matière principale recyclé: robuste tissu polyester fabriqué à partir de bouteilles PET recyclées (twist matière 50%), déperlant



WB 4005
navy

WB 4073
signature navy

WB 7003
black

WB 7009
dots

WB 7052
twist silver

COSMETICPOUCH M



↳ 26 x 17 x 9 cm
□ 3 l

VE/UNIT 4/24

• **Kulturbeutel im Unisex-Look, für Hygieneartikel, Kosmetik, Ladekabel und persönliche Dinge**

- Modernes 3-D-Steppdesign
- Hauptfach mit großer Reißverschlussöffnung
- 1 Reißverschlussfach und 2 Steckfächer aus Mesh innen
- 1 Tragegriff
- Fester Stand durch rechteckigen Boden
- Recyceltes Obermaterial: robustes Polyestergewebe aus recycelten PET-Flaschen, wasserabweisend

• **Toiletry bag in unisex look, for toiletries, cosmetics, charging cables and personal items**

- Modern 3-D quilted design
- Main compartment with large zipped opening
- 1 zipped compartment and 2 mesh pockets inside
- 1 carrying handle
- Stable due to rectangular bottom
- Recycled outer material: robust polyester fabric made from recycled PET bottles, water-repellent

• **Trousse de toilette au look unisexe, pour les articles de toilette, les cosmétiques, le câble de recharge et les objets personnels**

- Motif matelassé moderne en 3D
- Compartiment principal avec grande ouverture zippée
- 1 poignée de transport
- Stable grâce à sa base rectangulaire
- Matière principale recyclé : robuste tissu polyester fabriqué à partir de bouteilles PET recyclées, déperlant



BH 7059*
rhombus black



TRAVEL

CLASSIC BACKPACK M	88
DUFFELBAG M	89
NETBOOKBAG	90
WORKBAG	91
OVERNIGHTER-BACKPACK M	92
ALLDAY BACKPACK M	93
ALLROUNDER CROSS	94
ALLROUNDER R	95
DAYPACK	96
ALLROUNDER S POCKET	97
ALLROUNDER M	98
ALLROUNDER L	99
ALLROUNDER L POCKET	100
ALLROUNDER TROLLEY	101
OVERNIGHTER	102
OVERNIGHTER PLUS	103
ACTIVITYBAG	104
SEATPAD L	105

CLASSIC BACKPACK M



↳ 28 x 39 x 12 cm
□ 13 l

VE/UNIT 2/12

• **Durchdachter Rucksack im Unisex-Look für Arbeit, Reisen und Freizeit**

- Entspricht den vorgeschriebenen Maßen für Handgepäck
- Modernes 3-D-Steppdesign
- Geräumiges Hauptfach mit großer 2-Wege-Reißverschluss-Öffnung
- 1 Reißverschlussfach außen
- 1 Steckfach und 1 Reißverschlussfach innen
- Rückseite aus Mesh für hohen Tragekomfort
- 1 Tragegriff
- Verstellbare, gepolsterte Schultergurte
- Fester Stand durch rechteckigen Boden
- Recyceltes Obermaterial: robustes Polyestergewebe aus recycelten PET-Flaschen, wasserabweisend

• **Sophisticated backpack in unisex look for work, travel and leisure**

- Matches the prescribed dimensions for hand luggage
- Modern 3-D quilted design
- Spacious main compartment with large 2-way zipped opening
- 1 zipped compartment on the outside
- 1 pocket and 1 zipped pocket inside
- Mesh back for high carrying comfort
- 1 carrying handle
- Adjustable, padded shoulder straps
- Rectangular base for stability
- Recycled outer material: robust polyester fabric made from recycled PET bottles, water-repellent

• **Sac à dos sophistiqué au look unisexe pour le travail, les voyages et les loisirs**

- Conforme aux dimensions prescrites pour les bagages à main
- Motif matelassé moderne en 3D
- Large compartiment principal avec grande ouverture zippée à double sens
- 1 compartiment zippé à l'extérieur
- 1 compartiment et 1 poche zippée à l'intérieur
- Dos en filet pour un confort élevé
- 1 poignée
- Bretelles réglables et rembourrées
- Stable grâce à sa base rectangulaire
- Matière principale recyclée: robuste tissu polyester fabriqué à partir de bouteilles PET recyclées, déperlant



CJ 7059*
rhombus black

DUFFELBAG M



↳ 52 x 37 x 21 cm
 □ 38 l

VE/UNIT 4/12

• **Stylisher vielseitiger Begleiter für Wochenend-Trips, Businessreisen und Alltag**

- Entspricht den vorgeschriebenen Maßen für Handgepäck
- Modernes 3-D-Steppdesign
- Geräumiges Hauptfach mit großer 2-Wege-Reißverschluss-Öffnung
- 1 großes und 1 kleines Reißverschlussfach außen
- 1 großes Reißverschlussfach und 2 Mesh-Steckfächer innen
- Abnehmbarer, verstellbarer Schultergurt
- Fester Stand durch rechteckigen Boden
- Standfüße aus Kunststoff
- Recyceltes Obermaterial: robustes Polyestergewebe aus recycelten PET-Flaschen, wasserabweisend

• **Stylish versatile companion for weekend trips, business trips and everyday life**

- Matches the prescribed dimensions for hand luggage
- Modern 3-D quilted design
- Spacious main compartment with large 2-way zipped opening
- 1 large and 1 small zipped compartment on the outside
- 1 large zipped compartment and 2 mesh pockets inside
- Detachable, adjustable shoulder strap
- Rectangular base for stability
- Plastic base feet
- Recycled outer material: robust polyester fabric made from recycled PET bottles, water-repellent

• **Un compagnon élégant et polyvalent pour les week-ends prolongés, les voyages d'affaires et la vie quotidienne**

- Conforme aux dimensions prescrites pour les bagages à main
- Motif matelassé moderne en 3D
- Compartiment principal spacieux avec grande ouverture zippée à double sens
- 1 grand et 1 petit compartiment zippés à l'extérieur
- 1 large zipped compartment and 2 mesh pockets inside
- Bandoulière détachable et réglable
- Stable grâce à sa base rectangulaire
- Pieds en plastique
- Matière principale recyclé : robuste tissu polyester fabriqué à partir de bouteilles PET recyclées, déperlant



BG 7059*
 rhombus black

NETBOOKBAG



┌ 40 x 28,5 x 3,5 cm
□ 5 l

VE/UNIT 4/12

• **Praktische und stilvolle Tasche für Notebooks mit max. 15,6" Diagonale**

- Gepolstertes Hauptfach mit großer Reißverschlussöffnung
- 2 Steckfächer und 1 Reißverschlussfach außen
- 2 Tragevarianten durch Tragehenkel und abnehmbaren, verstellbaren Schultergurt
- Tragehenkel lassen sich in den Außenfächern verstauen
- Passt perfekt in den allrounder M
- Material: hochwertiges Polyester-gewebe, wasserabweisend

• **Practical and stylish bag for notebooks with a diagonal length of max. 15.6"**

- Padded main compartment with large zip opening
- 2 pockets and 1 zip pocket on the outside
- 2 carrying options with carrying handles and an adjustable, removable shoulder strap
- Carrying handles can be stored in outer compartments
- Fits perfectly in the allrounder M
- Material: premium-quality polyester, water-repellent

• **Sac pratique et élégant pour le transport d'ordinateurs portables ayant une diagonale de max. 15,6 pouces**

- Compartiment principal rembourré à grande fermeture zippée
- 2 compartiments et 1 compartiment à fermeture zippée à l'extérieur
- 2 façons de le porter grâce à ses poignées de transport et sa bandoulière réglable et amovible
- Les poignées de transport peuvent se ranger dans les compartiments extérieurs
- Se range parfaitement dans le allrounder M
- Matière : polyester de haute qualité, déperlant



MA 4059
dark blue



MA 7003
black



MA 7052
twist silver

WORKBAG



↳ 42,5 x 33 x 12 cm
 ☐ 13 l

VE/UNIT 4/12

• **Bestens organisiert: stylische Tasche für Business und Reisen**

- Frontfach mit Organizer, bestehend aus einem Reißverschlussfach, Steckfächern für Karten, Stiftschlaufen und gepolstertem Steckfach für Smartphones
- Rückseitiges Reißverschlussfach
- 3 Hauptfächer, passend für A4-Unterlagen
- Vorderes und hinteres Hauptfach mit Reißverschluss, mittleres Fach mit Magnet verschließbar
- Vorderes Hauptfach mit 2 Steckfächern und Reißverschlussfach mit Schlüsselhaken
- Hinteres Fach gepolstert für Laptop (15") oder Tablet
- Trolley-Aufsteckfunktion
- 2 kurze Tragehenkel und verstellbarer Tragegurt mit gepolsterter Mesh-Schulterauflage
- Recyceltes Obermaterial: robustes Polyestergewebe aus recycelten PET-Flaschen (twist Material 50%), wasserabweisend

• **Perfectly organised: a stylish bag for business and travelling**

- Front compartment with an organiser, consisting of a zip compartment, slots for cards, pen loops and 1 padded compartment for smartphones
- Rear zip compartment
- 3 main compartments to fit A4 documents
- Zipped main compartments at the front and rear, middle compartment with a magnetic close
- Front main compartment with 2 pockets and a zipped compartment with key hooks
- Rear compartment padded for a laptop (15") or tablet
- Sleeve for attaching to a trolley suitcase
- 2 short handles and an adjustable carry strap with mesh shoulder pad
- Recycled outer material: robust polyester fabric made from recycled PET bottles (twist material 50%), water-repellent

• **Organisation parfaite : un sac élégant aussi bien pour le travail que pour les voyages**

- Compartiment frontal avec organisateur, comprend un compartiment zippé, des emplacements pour cartes, des passants pour stylos et 1 poche rembourrée pour téléphone portable
- Poche zippée à l'arrière
- 3 compartiments principaux adaptés aux dossiers de format A4
- Compartiments avant et arrière à fermeture zippée, et compartiment central à fermeture aimantée
- Compartiment principal avant comprenant 2 poches de rangement et une poche zippée avec un porte-clés
- Compartiment arrière rembourré pour ordinateur portable (15 pouces) ou tablette
- Sangle sur le côté pour le glisser sur une valise à roulette
- 2 poignées et une bandoulière ajustable avec renfort pour l'épaule rembourré
- Matière principale recyclée : robuste tissu polyester fabriqué à partir de bouteilles PET recyclées (twist matière 50%), déperlant



US 7003
black



US 7052
twist silver

OVERNIGHTER-BACKPACK M



↳ 30 x 41 x 15 cm
□ 13 l

VE/UNIT 2/12

• Sportlich-extravaganter Rucksack für Alltag und Arbeit

- Entspricht den vorgeschriebenen Maßen für Handgepäck
- Geräumiges Hauptfach mit viel Platz
- Große Öffnung mit 2-Wege-Reißverschluss
- 1 Außenfach mit XXL-Reißverschluss
- 1 Reißverschlussfach innen im Deckel
- 1 gepolstertes Laptopfach (15,6") plus 1 Reißverschlussfach innen
- Rückseite aus Mesh für hohen Tragekomfort
- Verstellbare, gepolsterte Schultergurte
- 1 Tragehenkel
- Recyceltes Obermaterial: robustes Polyestergewebe aus recycelten PET-Flaschen (twist Material 50%), wasserabweisend

• Sporty and sophisticated backpack for everyday life and work

- Matches the prescribed dimensions for hand luggage
- Spacious main compartment with plenty of room
- Large opening with 2-way zip
- 1 outside compartment with XXL zip
- 1 zipped compartment inside the lid
- 1 padded laptop compartment (15,6") plus 1 zipped compartment inside
- Mesh back for high carrying comfort
- Adjustable, padded shoulder straps
- 1 carrying handle
- Recycled outer material: robust polyester fabric made from recycled PET bottles (twist material 50%), water-repellent

• Sac à dos sportif et extravagant pour la vie quotidienne et le travail

- Conforme aux dimensions prescrites pour les bagages à main
- Compartiment principal de grande contenance
- Grande ouverture avec fermeture zippée à double sens
- 1 compartiment extérieur avec zip XXL
- 1 compartiment zippé à l'intérieur du couvercle
- 1 compartiment rembourré pour ordinateur portable (15,6") et 1 compartiment intérieur zippé
- La face arrière du backpack en tissu mesh pour un confort maximum
- Bretelles réglables et rembourrées
- 1 poignée de transport
- Matière principale recyclé: robuste tissu polyester fabriqué à partir de bouteilles PET recyclées (twist matière 50%), déperlant



EG 4027*
twist blue



EG 4059*
dark blue



EG 7003*
black



EG 7052*
twist silver

ALLDAY BACKPACK M



↳ 30 x 39 x 13 cm
□ 15 l

VE/UNIT 2/12

• **Vielseitiger Tages-Rucksack für Arbeitsweg, Shoppingtour oder City-Trip**

- Entspricht den vorgeschriebenen Maßen für Handgepäck
- Geräumiges Hauptfach mit 2-Wege-Reißverschluss
- 1 großes und 1 kleines Reißverschlussfach außen
- 1 gepolstertes Laptopfach (15,6") und 1 Reißverschlussfach innen
- Verstellbare, gepolsterte Schultergurte
- 2 Tragegriffe
- Recyceltes Obermaterial: robustes Polyestergerewebe aus recycelten PET-Flaschen (twist Material 50%), wasserabweisend

• **Versatile day backpack for commuting, shopping or city trips**

- Matches the prescribed dimensions for hand luggage
- Spacious main compartment with 2-way zip
- 1 large and 1 small zipped compartment on the outside
- 1 padded laptop compartment (15,6") and 1 zipped compartment inside
- Adjustable, padded shoulder straps
- 2 carrying handles
- Recycled outer material: robust polyester fabric made from recycled PET bottles (twist material 50%), water-repellent

• **Sac à dos polyvalent pour le trajet domicile-travail, le shopping ou les déplacements en ville**

- Conforme aux dimensions prescrites pour les bagages à main
- Compartiment principal spacieux avec fermeture zippée à double sens
- 1 grand et 1 petit compartiment zippé à l'extérieur
- 1 compartiment rembourré pour ordinateur portable (15,6") et 1 compartiment zippé à l'intérieur
- Bretelles réglables et rembourrées
- 2 poignées de transport
- Matière principale recyclé : robuste tissu polyester fabriqué à partir de bouteilles PET recyclées (twist matière 50%), déperlant



EJ 3075*
mixed dots red



EJ 4027*
twist blue



EJ 4073*
signature navy



EJ 6041*
twist coffee



EJ 7003*
black



EJ 7009*
dots



EJ 7052*
twist silver

ALLROUNDER CROSS

**BEST
SELLER**

↳ 22 x 24 x 13 cm
□ 4 l

VE/UNIT 4/12

• **Angesagte Crossbody Bag für jeden Tag**

- Abnehmbarer, verstellbarer Schultergurt mit Karabinerhaken
- 2 Tragehenkel
- Öffnung mit Reißverschluss und eingearbeitetem Metallbügel
- 2 Reißverschlussfächer außen
- 3 Steckfächer und 1 Reißverschlussfach innen
- Seitenwände und Boden leicht gepolstert
- Material: hochwertiges Polyester-gewebe, wasserabweisend
- Recyceltes Obermaterial: robustes Polyestergewebe aus recycelten PET-Flaschen (twist Material 50%), wasserabweisend

• **Fashionable crossbody bag for every day**

- Removable, adjustable shoulder strap with snap hook
- 2 carrying handles
- Opening with zip and integrated metal frame
- 2 zip pockets on the outside
- 3 pockets and 1 zip pocket on the inside
- Lightly padded side walls and base
- Material: premium-quality polyester, water-repellent
- Recycled outer material: robust polyester fabric made from recycled PET bottles (twist material 50%), water-repellent

• **Un sac à bandoulière tendance pour tous les jours**

- Bandoulière réglable en longueur et amovible avec mousquetons
- 2 poignées
- Ouverture avec fermeture zippée et armature en métal intégrée
- 2 compartiments zippés extérieurs
- 3 compartiments et 1 compartiment à fermeture zippée à l'intérieur
- Côtés et fond légèrement rembourrés
- Matière : polyester de haute qualité, déperlant
- Matière principale recyclé : robuste tissu polyester fabriqué à partir de bouteilles PET recyclées (twist matière 50%), déperlant



MQ 1035*
twist sky rose



MQ 3075
mixed dots red



MQ 3077*
twist berry



MQ 4027
twist blue



MQ 4073
signature navy



MQ 6041*
twist coffee



MQ 7003
black



MQ 7052
twist silver



MQ 7054
signature black

ALLROUNDER R

**BEST
SELLER**

└ 31 x 39 x 17 cm
□ 12 l

VE/UNIT 2/12

• **Rundum mobil! Das durchdachte 2-in-1-Prinzip (handliche Tragetasche und Rucksack in einem) überzeugt auf Reisen wie auch auf dem Weg zur Uni oder ins Büro**

- Geräumiges Hauptfach (13"-Laptop)
- Große Öffnung mit Reißverschluss und eingearbeitetem Metallbügel
- 3 Steckfächer und 1 Reißverschlussfach innen
- 2 Steckfächer und 1 Reißverschlussfach außen
- Rückseitige Stecklasche zur Befestigung an Reisetrolley-Griffen
- 2 Tragehenkel
- Verstellbare Schultergurte
- Material: hochwertiges Polyester-gewebe, wasserabweisend
- Recyceltes Obermaterial: robustes Polyestergewebe aus recycelten PET-Flaschen (twist Material 50%), wasserabweisend

• **All-round mobile! Its smart 2-in-1 principle (convenient handbag and rucksack in one) makes it the perfect bag for all occasions, whether you're on holiday or headed to uni or work**

- Spacious main compartment (laptop 13")
- Large opening with zip and integrated metal frame
- 3 pockets and 1 zip pocket on the inside
- 2 pockets and 1 zip pocket on the outside
- Strap on back to attach to the handles of a trolley suitcase
- 2 carrying handles
- Adjustable shoulder straps
- Material: premium-quality polyester, water-repellent
- Recycled outer material: robust polyester fabric made from recycled PET bottles (twist material 50%), water-repellent

• **La mobilité en tout point ! L'astucieux principe 2 en 1 (sac cabas pratique et sac à dos) séduit en voyage de même que sur le chemin de l'université ou du bureau**

- Compartiment principal spacieux (ordinateur portable 15 pouces)
- Grande ouverture avec fermeture zippée et armature en métal intégrée
- 3 compartiments et 1 compartiment à fermeture zippée à l'intérieur
- 2 compartiments et 1 compartiment à fermeture zippée à l'extérieur
- Languette au dos pour fixer le sac sur les poignées d'une valise à roulettes
- 2 poignées
- Bandoulière réglable
- Matière : polyester de haute qualité, déperlant
- Matière principale recyclé : robuste tissu polyester fabriqué à partir de bouteilles PET recyclées (twist matière 50%), déperlant



JR 1035*
twist sky rose



JR 3075
mixed dots red



JR 3077*
twist berry



JR 4027
twist blue



JR 4073
signature navy



JR 6041*
twist coffee



JR 7003
black



JR 7009
dots



JR 7052
twist silver



JR 7054
signature black

TRAVEL

DAYPACK



↳ 37 x 43 x 13 cm
□ 18 l

VE/UNIT 2/12

• Das durchdachte 2-in-1-Prinzip (handliche Tragetasche und Rucksack in einem) überzeugt auf Reisen wie auch auf dem Weg zur Uni oder ins Büro

- Geräumiges Hauptfach
- Gepolsterter Innenteiler für Laptop (17") oder Tablet
- 1 kleines Reißverschlussfach außen
- Tragehenkel lassen sich per Klettverschluss koppeln
- Material: hochwertiges Polyester-gewebe, wasserabweisend

• Its smart 2-in-1 principle (convenient handbag and rucksack in one) makes it the perfect bag for all occasions, whether you're on holiday or headed to uni or work

- Spacious main compartment
- Padded inner compartment for laptop (17") or tablet
- 1 small zip pocket on the outside
- Carrying handles easily attachable with hook-and-loop fastening
- Material: premium-quality polyester, water-repellent

• L'astucieux principe 2 en 1 (sac cabas pratique et sac à dos) séduit en voyage, de même que sur le chemin de l'université ou du bureau

- Compartiment principal spacieux
- Compartiment séparateur rembourré pour ordinateur portable (17 pouces) ou tablette
- 1 petite poche zippée extérieure
- 1 bande auto-agrippante permet d'unir les 2 anses
- Matière : polyester de haute qualité, déperlant



HH 7052
twist silver

ALLROUNDER S POCKET



↳ 39 x 26 x 16,5 cm

□ 11 l

VE/UNIT 4/12

• Für Alltag, Reisen und Büro

- Öffnung mit Reißverschluss und eingearbeiteten Metallbügeln
- Abnehmbarer, verstellbarer Schultergurt mit hochwertigen Karabinerhaken
- 2 Tragehenkel
- 1 Reißverschlussfach außen
- Rückseitige praktische Trolley-Aufsteckfunktion
- 1 Reißverschlussfach und 3 Steckfächer innen
- Hauptfach passend für A4-Unterlagen
- Leicht gepolstert
- Recyceltes Obermaterial: robustes Polyestergewebe aus recycelten PET-Flaschen (twist Material 50%), wasserabweisend

• For everyday use, travel and the office

- Opening with zip and integrated metal brackets
- Removable, adjustable shoulder strap with high-quality snap hook
- 2 handles
- 1 outside zip pocket
- Practical trolley suitcase attachment function on the back
- 1 zip compartment and 3 open pockets inside
- Main compartment suitable for A4 documents
- Lightly padded
- Recycled outer material: robust polyester fabric made from recycled PET bottles (twist material 50%), water-repellent

• Pour un usage quotidien, les voyages et le bureau

- Ouverture par zip et supports métalliques intégrés
- Bandoulière amovible et réglable avec mousqueton de haute qualité
- 2 poignées
- 1 poche extérieure zippée
- Système pratique de fixation à la poignée d'une valise à roulettes
- 1 compartiment zippé et 3 poches ouvertes à l'intérieur
- Compartiment principal adapté aux documents A4
- Légèrement rembourré
- Matière principale recyclé : robuste tissu polyester fabriqué à partir de bouteilles PET recyclées (twist matière 50%), déperlant



MO 3075
mixed dots red



MO 4005
navy



MO 4027
twist blue



MO 4073
signature navy



MO 7003
black



MO 7009
dots



MO 7052
twist silver

ALLROUNDER M

**BEST
SELLER**

L 40 x 33,5 x 24 cm
□ 18 l

VE/UNIT 4/12

• **Das Prinzip der Dokortasche – neu durchdacht fürs Leben unterwegs!**

- Seitenwände und Boden leicht gepolstert
- Öffnung mit Reißverschluss und eingearbeitetem Metallbügel
- 6 Steckfächer innen zur praktischen Aufbewahrung
- Tragegurt mit komfortabel gepolsterter Schulterauflage
- 2 Tragehenkel mit Griffpolster
- Material: hochwertiges Polyester-gewebe, wasserabweisend
- Recyceltes Obermaterial: robustes Polyestergewebe aus recycelten PET-Flaschen (twist Material 50%), wasserabweisend

• **Modelled on the traditional doctor's bag: the contemporary interpretation of mobility!**

- Lightly padded sides and bottom
- Opening includes zip fastening and integrated metal bracket
- 6 inside pockets for practical storage
- Carrying strap with comfortably padded shoulder supports
- 2 carrying handles with padded grip
- Material: premium-quality polyester, water-repellent
- Recycled outer material: robust polyester fabric made from recycled PET bottles (twist material 50%), water-repellent

• **Un modèle inspiré par la traditionnelle sacoche de médecin, conçu pour les déplacements**

- Côtés et fond légèrement rembourrés
- Ouverture avec fermeture zippée et armature en métal intégrée
- 6 compartiments intérieurs pour un rangement pratique
- Bandoulière confortablement rembourrée au niveau de l'épaule
- 2 poignées de transport confortables
- Matière : polyester de haute qualité, déperlant
- Matière principale recyclé : robuste tissu polyester fabriqué à partir de bouteilles PET recyclées (twist matière 50%), déperlant



MS 1035*
twist sky rose



MS 3075
mixed dots red



MS 3077*
twist berry



MS 4027
twist blue



MS 4073
signature navy



MS 4088*
florist indigo



MS 6041*
twist coffee



MS 7003
black



MS 7009
dots



MS 7027
baroque taupe



MS 7052
twist silver



MS 7054
signature black

ALLROUNDER L

**BEST
SELLER**

⌄ 48 x 39,5 x 29 cm
 ☐ 30 l

VE/UNIT 4/12

• **Das Prinzip der Dokortasche – neu durchdacht fürs Leben unterwegs!**

- Seitenwände und Boden leicht gepolstert
- Öffnung mit Reißverschluss und eingearbeitetem Metallbügel
- 6 Steckfächer innen zur praktischen Aufbewahrung
- Tragegurt mit komfortabel gepolsterter Schulterauflage
- 2 Tragehenkel mit Griffpolster
- Material: hochwertiges Polyester-gewebe, wasserabweisend
- Recyceltes Obermaterial: robustes Polyestergewebe aus recycelten PET-Flaschen (twist Material 50%), wasserabweisend

• **Modelled on the traditional doctor's bag: the contemporary interpretation of mobility!**

- Lightly padded sides and bottom
- Opening includes zip fastening and integrated metal bracket
- 6 inside pockets for practical storage
- Carrying strap with comfortably padded shoulder supports
- 2 carrying handles with padded grip
- Material: premium-quality polyester, water-repellent
- Recycled outer material: robust polyester fabric made from recycled PET bottles (twist material 50%), water-repellent

• **Un modèle inspiré par la traditionnelle sacoche de médecin, conçu pour les déplacements**

- Côtés et fond légèrement rembourrés
- Ouverture avec fermeture zippée et armature en métal intégrée
- 6 compartiments intérieurs pour un rangement pratique
- Bandoulière confortablement rembourrée au niveau de l'épaule
- 2 poignées de transport confortables
- Matière : polyester de haute qualité, déperlant
- Matière principale recyclé : robuste tissu polyester fabriqué à partir de bouteilles PET recyclées (twist matière 50%), déperlant



MT 1035*
twist sky rose



MT 3075
mixed dots red



MT 3077*
twist berry



MT 4027
twist blue



MT 4073
signature navy



MT 4088*
florist indigo



MT 6041*
twist coffee



MT 7003
black



MT 7009
dots



MT 7027
baroque taupe



MT 7052
twist silver



MT 7054
signature black

ALLROUNDER L POCKET



L 48 x 39,5 x 29 cm

□ 32 l

VE/UNIT 4/12

• Der Klassiker mit noch mehr Platz!

- 2 große Reißverschlusstaschen außen vergrößern den Stauraum
- Prinzip der Dokortasche mit großer Bügelöffnung
- Fester Boden mit 5 Standfüßen für 100 % Bodenfreiheit
- Praktische Trolley-Aufsteckfunktion
- 6 Steckfächer innen
- Tragegurt mit komfortabel gepolsterter Schulterauflage
- 2 Tragehenkel mit Griffpolster
- Material: hochwertiges Polyester-gewebe, wasserabweisend
- Recyceltes Obermaterial: robustes Polyestergewebe aus recycelten PET-Flaschen (twist Material 50%), wasserabweisend

• The classic with even more space!

- More storage space thanks to 2 large, zip pockets on the outside
- Doctor's-bag design with a large reinforced opening
- Firm base with 5 base feet pegs to keep bottom off the ground
- Can be conveniently attached to a trolley suitcase
- 6 inner compartments
- Shoulder strap with comfortable padding
- 2 padded carrying handles
- Material: high-quality polyester, water-repellent
- Recycled outer material: robust polyester fabric made from recycled PET bottles (twist material 50%), water-repellent

• Un modèle classique offrant encore plus d'espace !

- 2 grands compartiments avec fermeture zippée à l'extérieur agrandissent l'espace de rangement
- Conception similaire à celle d'une sacoche de médecin avec une grande ouverture à arceaux
- Fond solide doté de 5 pieds pour une entière liberté au sol
- Système de fixation à la poignée d'une valise à roulettes très pratique
- 6 compartiments intérieurs
- Bandoulière avec renfort d'épaule confortable et rembourré
- 2 poignées de transport avec rembourrage
- Matière : tissu en polyester de haute qualité, déperlant
- Matière principale recyclé : robuste tissu polyester fabriqué à partir de bouteilles PET recyclées (twist matière 50%), déperlant



MK 3075
mixed dots red



MK 4073
signature navy



MK 7003
black



MK 7009
dots



MK 7052
twist silver



MK 7054
signature black

ALLROUNDER TROLLEY



↳ 49 x 41 x 30 cm

☐ 30 l

VE/UNIT 1/2

• Der Klassiker zum Rollen

- Große Öffnung mit Reißverschluss und eingearbeitetem Metallbügel
- 6 Steckfächer innen
- 2 Reißverschlusstaschen außen
- Seitenwände leicht gepolstert
- 2 Tragehenkel mit Griffpolster
- 2 leicht laufende Rollen
- 2-fach höhenverstellbare Teleskopstange
- Boden-Protektoren
- Standfüße für 100% Bodenfreiheit
- Material: hochwertiges Polyestergewebe, wasserabweisend

• The classic on wheels

- Large zip opening and integrated metal frame
- 6 compartments on the inside
- 2 zip pockets on the outside
- Lightly padded side walls
- 2 padded carrying handles
- 2 smooth-turning wheels
- 2-stage telescopic handle
- Base protectors for rougher terrain
- Plastic feet for 100% ground clearance
- Material: premium-quality polyester, water-repellent

• Notre grand classique à roulettes

- Grande ouverture avec fermeture zippée et armature en métal intégrée
- 6 compartiments intérieurs
- 2 compartiments avec fermeture zippée à l'extérieur
- Parois latérales légèrement rembourrées
- 2 poignées de transport rembourrées
- 2 roues ultramaniabiles
- Poignée télescopique réglable en hauteur sur 2 niveaux
- Éléments protecteurs sur le fond pour rouler sur tous les types de terrains
- Pieds pour une entière liberté au sol
- Matière : polyester de haute qualité, déperlant



MP 4059
dark blue



MP 7003
black



MP 7009
dots



MP 7052
twist silver

OVERNIGHTER



↑, 60 x 34 x 26 cm
 □ 45 l

VE/UNIT 2/12

• **Travel in Style: die perfekte Reisetasche für Kurztrips und Traumziele**

- Großes Hauptfach mit XXL-Reißverschluss
- 2 Steckfächer vorne
- Innen: 2 Steckfächer und Organizer, bestehend aus 1 Reißverschlussfach und 2 Steckfächern, davon 1 gepolstert für Smartphones
- 2 Tragehenkel mit Klettkopplung und verstellbarer Tragegurt mit gepolsterter Schulterauflage
- Trolley-Aufsteckfunktion
- Standfüße aus Kunststoff
- Material: hochwertiges Polyestergewebe, wasserabweisend

• **Travel in style: the perfect travel bag for short breaks and dream destinations**

- Large main compartment with XXL zip
- 2 pockets at the front
- Inside: 2 pockets plus an organiser consisting of a zip compartment and 2 pockets, 1 of which is padded for smartphones
- 2 carrying handles with hook-and-loop fastening and an adjustable carry strap with a shoulder pad
- Sleeve for attaching to a trolley suitcase
- Plastic base feet
- Material: premium-quality polyester, water-repellent

• **Un sac de voyage élégant : idéal pour les courtes escapades**

- Grand compartiment principal à fermeture zippée XXL
- 2 poches de rangement extérieures
- Intérieur : 2 compartiments en maille filet, un organisateur avec poche zippée et 2 poches de rangement dont une rembourrée pour y ranger un téléphone portable
- Poignées latérales joignables par bande auto-agrippante et bandoulière ajustable avec support d'épaule rembourré
- Sangle sur le côté pour le glisser sur une valise à roulettes
- Pieds en plastique
- Matière : polyester de haute qualité, déperlant



BS 4027
twist blue



BS 7052
twist silver

OVERNIGHTER PLUS



┆ 70 x 38 x 29 cm

□ 50 l

VE/UNIT 2/12

• **Extragroße, clevere Reise-/Sporttasche**

- Großes Hauptfach mit XXL-Reißverschluss
- Seitliches Schuhfach mit Zugriff von außen
- 3 Reißverschlussfächer außen
- Innen: 2 Steckfächer, 1 Reißverschlussfach
- 2 Tragegriffe mit Klettkopplung und verstellbarer Tragegurt mit gepolsterter Schulterauflage
- Standfüße aus Kunststoff
- Recyceltes Obermaterial: robustes Polyestergerewebe aus recycelten PET-Flaschen (twist Material 50%), wasserabweisend

• **Extra-large, smart travel/sports bag**

- Large main compartment with XXL zip
- Side shoe compartment with access from the outside
- 3 zipped compartments on the outside
- Inside: 2 pockets, 1 zipped pockets
- 2 carrying handles with Velcro fastening and adjustable shoulder strap with padded shoulder pad
- Plastic base feet
- Recycled outer material: robust polyester fabric made from recycled PET bottles (twist material 50%), water-repellent

• **Sac de voyage/sport extra-large et intelligent**

- Grand compartiment principal avec fermeture zippée XXL
- Compartiment latéral pour chaussures avec accès par l'extérieur
- 3 compartiments zippés à l'extérieur
- À l'intérieur : 2 poches à glissière, 1 compartiment zippé
- 2 poignées de transport avec fermeture à bande auto-agrippante et bandoulière réglable avec rembourrage pour les épaules
- Pieds en plastique
- Matière principale recyclé : robuste tissu polyester fabriqué à partir de bouteilles PET recyclées (twist matière 50%), déperlant



DM 4027*
twist blue



DM 4059*
dark blue



DM 7003*
black



DM 7052*
twist silver

ACTIVITYBAG



⌘ 54 x 33 x 30 cm
 □ 35 l

VE/UNIT 4/12

• Die dynamische Tasche für Sport oder Reisen

- Hauptfach mit 2-Wege-Reißverschluss
- 2 Netz-Einsteckfächer innen
- 2 seitliche Reißverschlussfächer, 1 davon mit Schuh-/Wäschebeutel
- 1 Steckfach außen
- 2 Tragehenkel mit Klettverschluss und verstellbarer Tragegurt mit gepolsterter Schulterauflage
- 5 Standfüße am Boden schützen vor Nässe und Schmutz
- Material: hochwertiges Polyester-gewebe, wasserabweisend
- Recyceltes Obermaterial: robustes Polyestergewebe aus recycelten PET-Flaschen (twist Material 50%), wasserabweisend

• A dynamic bag to take to the gym or on trips

- Main compartment with 2-way zip
- 2 inner net pockets
- 2 zip pockets on the outer sides of the bag, 1 of which can be used as a shoe or laundry bag
- 1 outer pocket
- 2 carrying handles with hook-and-loop fastening and an adjustable carry strap with a shoulder pad
- 5 base feet to protect the bag from getting wet or dirty
- Material: premium-quality polyester, water-repellent
- Recycled outer material: robust polyester fabric made from recycled PET bottles (twist material 50%), water-repellent

• Sac dynamique pour le sport ou les voyages

- Compartiment principal à fermeture zippée à double sens
- 2 pochettes en filet dans le compartiment principal
- 2 poches latérales à fermeture zippée, dont l'une pour chaussures ou vêtements
- 1 pochette extérieure
- Poignées latérales joignables par bande auto-agrippante et bandoulière ajustable avec support d'épaule rembourré
- 5 pieds pour protéger le sac de l'humidité et des salissures
- Matière : polyester de haute qualité, déperlant
- Matière principale recyclé : robuste tissu polyester fabriqué à partir de bouteilles PET recyclées (twist matière 50%), déperlant



MX 3075
mixed dots red

MX 4059
dark blue

MX 7003
black

MX 7027
baroque taupe

MX 7052
twist silver

SEATPAD L



L, 39 x 28 x 0,7 cm

VE/UNIT 30/120

• Für ein trockenes und gegen Kälte isoliertes Plätzchen im Freien

- Geringes Packmaß, da auf ein Viertel zusammenfaltbar
- Material: hochwertiges Polyester-gewebe, wasserabweisend

• Provides a dry, insulated spot outdoors

- Can be folded to a quarter of its size to save space
- Material: premium-quality polyester, water-repellent

• Un coussin qui vous garde au sec et au chaud lors de vos excursions

- Pliable en quatre pour ne pas prendre de place
- Matière : polyester de haute qualité, déperlant



SL 3004
red



SL 4005
navy



SL 7003
black



SL 7043
basalt

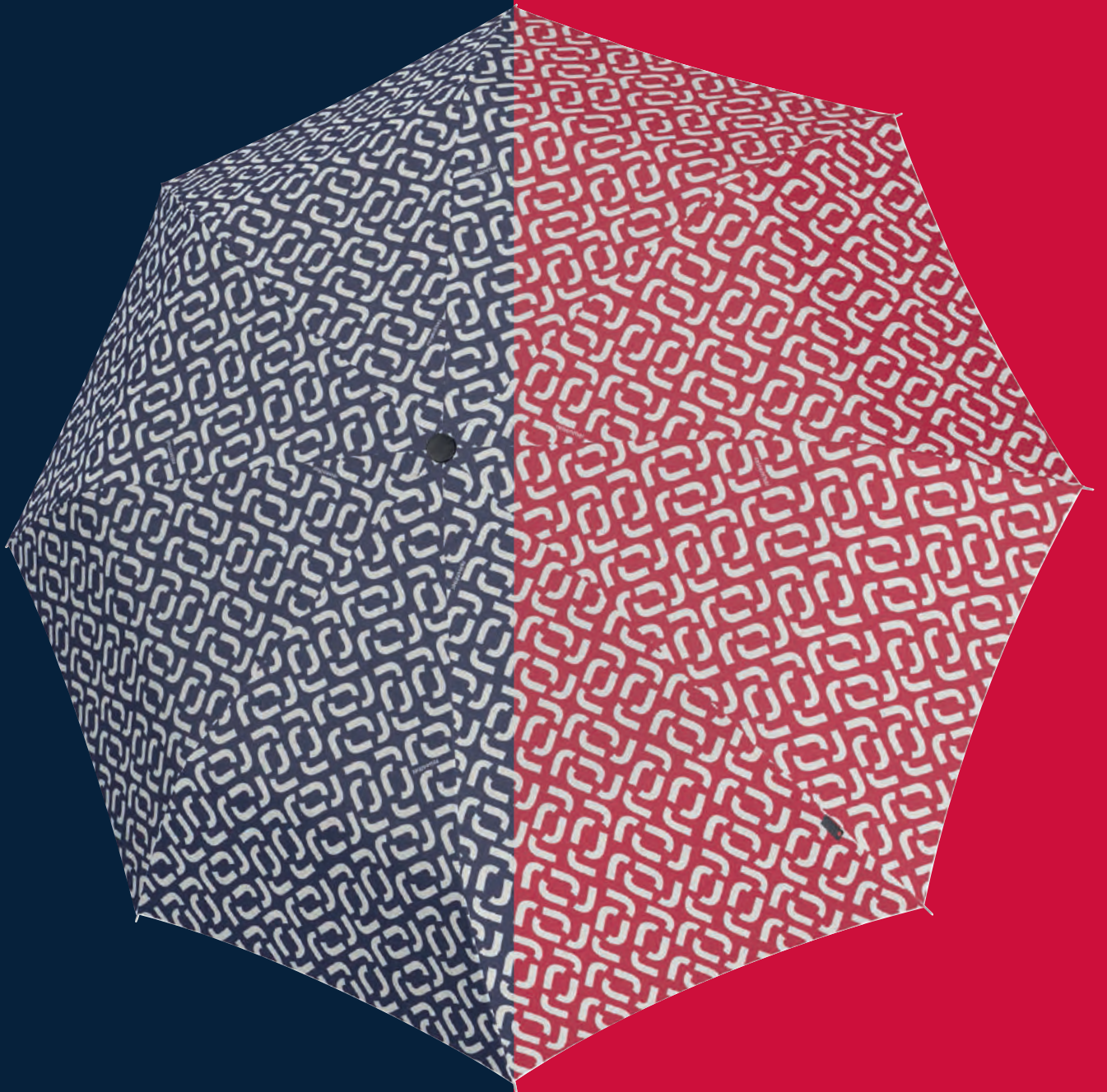

UMBRELLA POCKET MINI	108
UMBRELLA POCKET CLASSIC	109
UMBRELLA POCKET DUOMATIC	111



umbrella pocket mini

mini maxi als Taschenschirm!
Extrem leicht und flach.
Ausgestattet mit großem Schirm-
dach und langem Stock ist er ein
wahres Kleinraumwunder.

mini maxi as a pocket umbrella!
Extremely light and flat and yet with
a large roof and long stick, it's a
space-saving miracle.

Un parapluie mini maxi au format poche !
Extrêmement léger et plat. Avec
sa grande toile et son long mât, c'est
un petit génie qui a tout d'un grand.



umbrella pocket classic

Klassisch, stabil und zeitlos! Der
praktische, leichtgängige Hand-
öffner ist mit seinem sportlichen
Gestell aus Stahl und Fiberglas
passend für sie und ihn.

Classic, stable and timeless! The practical,
easy-to-use hand opener with its sporty
steel and fiberglass frame is suitable for
him and her.

Classique, robuste et intemporel ! Avec
son ouverture manuelle tant facile
que pratique et son cadre sportif en
acier et fibre de verre, il convient aux
femmes comme aux hommes.



umbrella pocket duomatic

Duo-Automatikkomfort der Extra-
Klasse mit elegantem Design! Die
große Drucktaste sorgt für leichtes,
automatisches Öffnen und Schließen.
Bequemer geht es nicht.

Duo-automatic comfort in a class of its
own with an elegant design! The large
push button ensures comfortable and
easy automatic opening and closing.

Le confort de l'automatique et
l'élégance du design ! Le grand bou-
ton-poussoir garantit une ouverture
et une fermeture automatiques d'une
seule main. Il n'y a pas plus pratique.

UMBRELLA POCKET MINI



97 cm



25 cm



100 km/h

VE/UNIT 2/24

• Extrem flacher, stabiler und leichter Taschenschirm, mit nur 2,5 cm ideal für die Tasche

- Leichtgängiger Handöffner mit großem Schirmdach trotz des kleinen Packmaßes
- Angenehmer Tragekomfort durch langen, silberfarbenen Stock
- Robuste Aluminiumleichtbauweise: Stahlstock, Schiene aus Aluminium
- Sturmfest: regelmäßige Tests im Windkanal bis 100 km/h
- Überschlagnssicher: keine Beschädigung durch Umklappen des Schirmdachs
- Sitzt fest in der Hand durch exklusives Griffdesign und Handschlaufe
- In original Schutzhülle kompakt zu verstauen
- Nach jedem Regeneinsatz aufgespannt trocknen
- Gewicht: 190 g
- Bezugsstoff: robustes Polyestergewebe aus recycelten PET-Flaschen, schnelltrocknend, wasserabweisend

• Extremely flat, stable and light pocket umbrella, with only 2.5 cm perfect for bags

- Smooth-running hand opener with a large roof despite the small pack size
- Comfortable to carry thanks to the long aluminium-colored stick
- Robust lightweight aluminium construction: steel frame, aluminum rail
- Storm proof: regular tests in the wind tunnel up to 100 km/h
- Flip-over proof: no damage by folding down the roof
- Sits firmly in the hand thanks to the exclusive handle design and wrist strap
- Can be stowed compactly in the original protective cover
- Leave open to dry after use
- Weight: 190 g
- Cover fabric: robust polyester fabric made from recycled PET bottles, quick-drying, water-repellent

• Parapluie pliant extrêmement plat, robuste et léger, avec seulement 2,5 cm de diamètre, idéal pour le ranger dans un sac

- Ouverture manuelle facile avec un grand toit malgré sa petite taille une fois plié
- Confortable à porter grâce au long mât en aluminium
- Armature robuste en aluminium léger: cadre en acier, baleine en aluminium
- Spécial tempête: tests réguliers en soufflerie jusqu'à 100 km/h
- Résistant au vent: aucun dommage en cas de retournement de la couverture
- Parfaite prise en main grâce à une conception exclusive de la poignée et de la dragonne
- Se range de manière compacte dans la housse d'origine
- Après chaque utilisation sous la pluie, laisser sécher ouvert
- Poids: 190 g
- Matériau textile: robuste tissu polyester fabriqué à partir de bouteilles PET recyclées, séchage rapide, déperlant

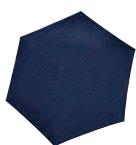

RT 3075
mixed dots red

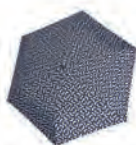

RT 4073
signature navy



RT 7009
dots



RT 7027
baroque taupe



RT 7052
twist silver

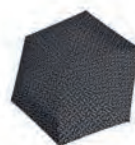

RT 7054
signature black



RT 7058
signature black hot print

UMBRELLA POCKET CLASSIC



VE/UNIT 2/24

• Der zeitlose, stylische und kompakte Taschenschirm-Klassiker

- Leichtgängiger Handöffner mit großem Schirmdach
- Sehr stabil durch robusten Materialmix aus Stahl und Fiberglas
- Sportliches, schwarzes Gestell
- Sturmfest: regelmäßige Tests im Windkanal bis 80 km/h
- Überschlagsicher: keine Beschädigung durch Umklappen des Schirmdachs
- Sitzt fest in der Hand durch exklusives, ergonomisches Griffdesign und Handschlaufe
- In original Schutzhülle kompakt zu verstauen
- Nach jedem Regeneinsatz aufgespannt trocknen
- Gewicht: 270 g
- Bezugsstoff: robustes Polyestergewebe aus recycelten PET-Flaschen, schnelltrocknend, wasserabweisend

• The timeless, stylish and compact pocket umbrella classic

- Smooth hand opener with large roof
- Very stable thanks to a robust material mix of steel and fiberglass
- Sporty frame in black
- Storm proof: regular tests in the wind tunnel up to 80 km/h
- Flip-over proof: no damage by folding down the roof
- Sits firmly in the hand thanks to the exclusive, ergonomic handle design and wrist strap
- Can be stowed compactly in the original protective cover
- Leave open to dry after use
- Weight: 270 g
- Cover fabric: robust polyester fabric made from recycled PET bottles, quick-drying, water-repellent

• Le classique du parapluie pliant, intemporel, stylé et compact

- Ouverture manuelle facile avec une grande couverture
- Très robuste grâce à un matériau solide d'un mélange acier et fibre de verre
- Cadre sportif en noir
- Spécial tempête: tests réguliers en soufflerie jusqu'à 80 km/h
- Résistant au vent: aucun dommage en cas de retournement de la couverture
- Parfaite prise en main grâce à une conception exclusive et ergonomique de la poignée et de la dragonne
- Se range de manière compacte dans la housse d'origine
- Après chaque utilisation sous la pluie, laisser sécher ouvert
- Poids: 270 g
- Matériau textile: robuste tissu polyester fabriqué à partir de bouteilles PET recyclées, séchage rapide, déperlant



RS 3070
signature red



RS 3075
mixed dots red



RS 4073
signature navy



RS 7009
dots



RS 7027
baroque taupe



RS 7052
twist silver



RS 7054
signature black



RS 7058
signature black
hot print

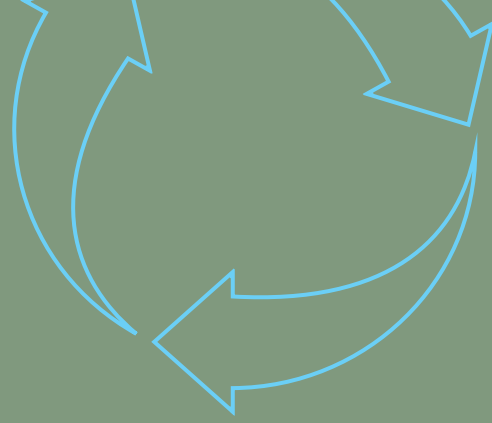
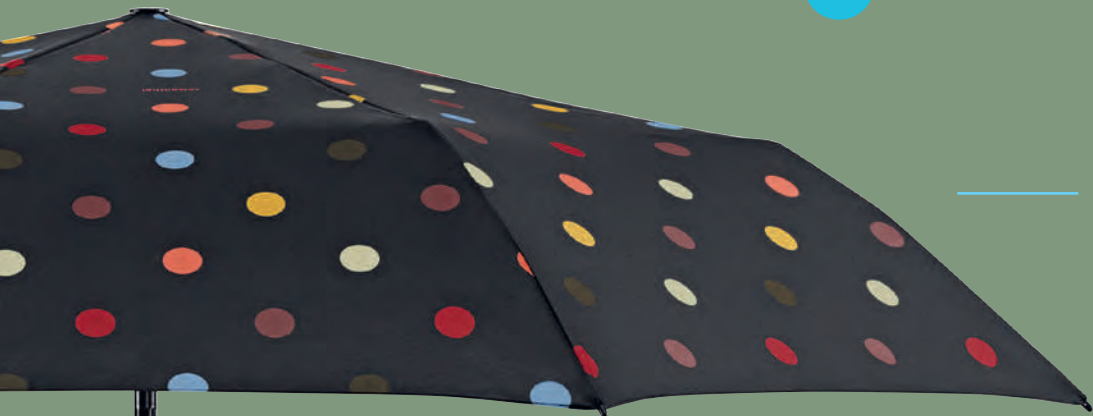

Bezugsstoff: robustes Polyestergewebe aus recycelten PET-Flaschen, schnelltrocknend, wasserabweisend

Cover fabric: robust polyester fabric made from recycled PET bottles, quick-drying, water-repellent

Materiau textile : robuste tissu polyester fabriqué à partir de bouteilles PET recyclées, séchage rapide, déperlant

Automatisches Öffnen und Schließen ...

Automatic opening and closing ... | Ouverture et fermeture automatique ...

... durch große Drucktaste
... with a large push button
... avec un gros bouton poussoir



Knirps

UMBRELLA POCKET DUOMATIC DER PERFORMER

REISENTHIEL + KNIRPS

UMBRELLA POCKET DUOMATIC

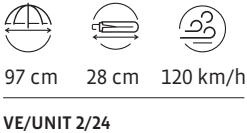

• Duomatik-Komfort mit elegantem Design

- Große Drucktaste für angenehmes, automatisches Öffnen und Schließen mit einer Hand
- Sehr stabil durch robusten Materialmix aus Stahl und Fiberglas
- Sportliches schwarzes Gestell
- Sturmfest: regelmäßige Tests im Windkanal bis 120 km/h
- Überschlagsicher: keine Beschädigung durch Umklappen des Schirmdachs
- Sitzt fest in der Hand durch exklusives, ergonomisches Griffdesign und Handschlaufe
- In original Schutzhülle kompakt zu verstauen
- Nach jedem Regeneinsatz aufgespannt trocknen
- Gewicht: 350 g
- Bezugsstoff: robustes Polyestergewebe aus recycelten PET-Flaschen, schnelltrocknend, wasserabweisend

• Duomatic comfort with an elegant design

- Large push button for convenient, automatic opening and closing with one hand
- Very stable thanks to a robust material mix of steel and fiberglass
- Sporty frame in black
- Storm proof: regular tests in the wind tunnel up to 120 km/h
- Flip-over-proof: no damage by folding down the roof
- Sits firmly in the hand thanks to the exclusive, ergonomic handle design and wrist strap
- Can be stowed compactly in the original protective cover
- Leave open to dry after use
- Weight: 350 g
- Cover fabric: robust polyester fabric made from recycled PET bottles, quick-drying, water-repellent

• Allie confort de l'automatique et l'élégance du design

- Grand bouton-poussoir pour une ouverture et une fermeture automatique d'une seule main
- Très robuste grâce à un matériau solide d'un mélange acier et fibre de verre
- Cadre sportif en noir
- Spécial tempête: tests réguliers en soufflerie jusqu'à 120 km/h
- Résistant au vent : aucun dommage en cas de retournement de la couverture
- Parfaite prise en main grâce à une conception exclusive et ergonomique de la poignée et de la dragonne
- Se range de manière compacte dans la housse d'origine
- Après chaque utilisation sous la pluie, laisser sécher ouvert
- Poids: 350 g
- Matériau textile : robuste tissu polyester fabriqué à partir de bouteilles PET recyclées, séchage rapide, déperlant



RR 3075
mixed dots red



RR 4073
signature navy



RR 7009
dots



RR 7027
baroque taupe



RR 7052
twist silver



RR 7054
signature black



RR 7058
signature black
hot print



KIDS

CARRYBAG XS KIDS	114
THERMOCASE KIDS	115
MYSAC KIDS	116
BACKPACK KIDS	117
TOILETBAG S KIDS	118
TOILETBAG KIDS	119
ALLROUNDER XS KIDS	120
ALLROUNDER M KIDS	121
TROLLEY XS KIDS	123
BABYCASE	124
BABY ORGANIZER	125

KIDS

CARRYBAG® XS KIDS

**BEST
SELLER**



└ 33,5 x 18 x 19,5 cm
□ 5 l

VE/UNIT 2/12

• Das Nesthäkchen in der carrybag Familie!

- Superweicher, klappbarer Tragegriff
- Innentasche mit Reißverschluss
- Reflektierende Elemente für bessere Sichtbarkeit bei Dunkelheit und schlechtem Wetter
- panda/tiger: mit hochwertiger Bestickung
- Belastbar bis 8 kg
- Material: hochwertiges, reißfestes Polyestergewebe, wasserabweisend
- Recyceltes Obermaterial: robustes Polyestergewebe aus recycelten PET-Flaschen, wasserabweisend

• The baby of the carrybag family!

- Ultra-soft folding handle
- Zip interior compartment
- Reflective elements for better visibility in the dark and in bad weather
- panda/tiger: with premium embroidery
- Loadable up to 8 kg
- Material: premium-quality, tear-proof polyester, water-repellent
- Recycled outer material: robust polyester fabric made from recycled PET bottles, water-repellent

• Le petit dernier de la famille carrybag !

- Poignée souple rabattable
- Poche intérieure zippée
- Éléments réfléchissants pour une meilleure visibilité dans l'obscurité et par mauvais temps
- panda/tiger : avec une broderie de haute qualité
- Résistant jusqu'à 8 kg
- Matière : polyester de haute qualité, indéchirable et déperlant
- Matière principale recyclée : robuste tissu polyester fabriqué à partir de bouteilles PET recyclées, déperlant



IA 3072
panda dots pink



IA 4077
tiger navy



IA 3064

cats and dogs rose



IA 4062

cats and dogs mint



IA 3066

ABC friends pink



IA 4066

ABC friends blue

THERMOCASE KIDS

**BEST
SELLER**



↳ 20 x 14 x 6,5 cm

☐ 1,5 l

* insulated

☑ machine wash cold

VE/UNIT 4/24

• Ab in die große Pause!

- Das Lunchpaket bleibt lange frisch dank des Thermo-Innenfutters aus Aluminiumfolie
- Kinderleichtes Öffnen und Schließen mit Reißverschluss
- Mit dem Tragegriff hat man die thermocase kids immer fest in der Hand
- 1 Extra-Netzfach innen
- panda/tiger: mit hochwertiger Bestickung
- Material: hochwertiges, reißfestes Polyestergewebe, wasserabweisend
- Recyceltes Obermaterial: robustes Polyestergewebe aus recycelten PET-Flaschen, wasserabweisend

• Time to take a break!

- The thermal lining made of aluminium foil keeps lunch fresh for longer
- A convenient zip for easy opening and closing
- The carrying strap lets you always keep a hand on your thermocase kids
- 1 extra mesh pocket inside
- panda/tiger: with premium embroidery
- Material: premium-quality, tear-proof polyester, water-repellent
- Recycled outer material: robust polyester fabric made from recycled PET bottles, water-repellent

• C'est l'heure du goûter !

- Garde les aliments au frais grâce à la doublure isotherme en feuille d'aluminium
- Ultrafacile à ouvrir et à fermer grâce à sa fermeture zippée
- Poignée pratique pour avoir la sacoche toujours bien en main
- Compartiment filet à l'intérieur
- panda/tiger : avec une broderie de haute qualité
- Matière : polyester de haute qualité, indéchirable et déperlant
- Matière principale recyclé : robuste tissu polyester fabriqué à partir de bouteilles PET recyclées, déperlant



OY 3072
panda dots pink



OY 4077
tiger navy



OY 3064
cats and dogs rose



OY 4062
cats and dogs mint



OY 3066
ABC friends pink



OY 4066
ABC friends blue

MYSAC KIDS



↑, 30 x 34 cm

☐ 5 l

🌀 machine wash cold

VE/UNIT 4/48

• **Der ideale Beutel für Sport und Reisen – sportlich, schick und unschlagbar cool!**

- Geräumiges Hauptfach, mit praktischem Kordelzug verschließbar
- Geht nicht verloren: Namensschild innen
- Material: hochwertiges, reißfestes Polyestergewebe, wasserabweisend

• **The perfect sports and travel bag – sporty elegance and unrivalled coolness!**

- Spacious main compartment, practical drawstring
- You can't lose it: name plate inside
- Material: premium-quality, tear-proof polyester, water-repellent

• **Le sac idéal pour le sport et en voyage – à la fois chic et très cool !**

- Vaste compartiment principal fermant à l'aide d'une cordelette pratique
- Ne risque pas de se perdre grâce au porte-nom à l'intérieur
- Matière : polyester de haute qualité, indéchirable et déperlant



IC 3064
cats and dogs rose



IC 4062
cats and dogs mint



IC 3066
ABC friends pink



IC 4066
ABC friends blue

BACKPACK KIDS

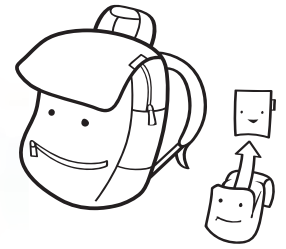

↑, 21 x 28 x 12 cm
□ 5 l

VE/UNIT 2/6

• Der ideale Rucksack für kleine Weltenbummler!

- Geräumiges Hauptfach plus Trinkflaschenfach außen
- Ergonomische, gepolsterte, verstellbare Gurte
- Rückenpolsterung als Sitzmatte nutzbar
- panda/tiger: mit hochwertiger Bestickung
- cats and dogs/ABC friends: reflektierende Elemente für bessere Sichtbarkeit
- Namensschild innen
- Material: hochwertiges, reißfestes Polyestergewebe, wasserabweisend
- Recyceltes Obermaterial: robustes Polyestergewebe aus recycelten PET-Flaschen, wasserabweisend

• The perfect rucksack for globetrotting kids!

- Spacious main compartment plus exterior drinking bottle compartment
- Ergonomic padded adjustable straps
- Back padding doubles as seat pad
- panda/tiger: with premium embroidery
- cats and dogs/ABC friends: reflective elements for better visibility
- Name tag inside
- Material: premium-quality, tear-proof polyester, water-repellent
- Recycled outer material: robust polyester fabric made from recycled PET bottles, water-repellent

• Le sac à dos idéal pour les petits globe-trotters !

- Vaste compartiment principal avec, en plus, une poche extérieure pour glisser sa boisson
- Sangles ergonomiques matelassées et réglables
- Le matelassage du dos peut être utilisé comme coussin
- panda/tiger : avec une broderie de haute qualité
- cats and dogs/ABC friends : éléments réfléchissants • Porte-nom à l'intérieur
- Matière : polyester de haute qualité, indestructible et déperlant
- Matière principale recyclée : robuste tissu polyester fabriqué à partir de bouteilles PET recyclées, déperlant



IE 3072
panda dots pink



IE 4077
tiger navy



IE 3064
cats and dogs rose



IE 4062
cats and dogs mint



IE 3066
ABC friends pink



IE 4066
ABC friends blue

TOILETBAG S KIDS



↳ 18,5 x 16 x 7 cm
(18,5 x 43 x 7 cm)

☐ 1,5 l

VE/UNIT 4/36

• Der Kinder-Kulturbbeutel für alle Reisen und zu Hause

- Hauptfach aus Netzmaterial mit 3 Steckschlaufen, 1 Reißverschlusstasche, Steckfach und Gummischlaufe
- Aufhängen und fertig!
Plus: Namensschild innen
- Material: hochwertiges, reißfestes Polyestergewebe, wasserabweisend

• Children's toiletries bag for holidays and home

- Main mesh compartment with 3 holders, 1 zip pocket, compartment and elastic holder
- Hang it up and go!
Plus: name tag inside
- Material: premium-quality, tear-proof polyester, water-repellent

• Trousse de toilette pour enfants, à utiliser chez soi ou en voyage

- D'une contenance insoupçonnée avec son compartiment principal en filet, 3 compartiments additionnels, 1 poche zippée et une boucle caoutchoutée pour la suspendre
- S'accroche tout simplement à l'endroit souhaité !
Le petit plus : porte-nom à l'intérieur
- Matière : polyester de haute qualité, indéchirable et déperlant



IO 3064
cats and dogs rose



IO 4062
cats and dogs mint



IO 3066
ABC friends pink



IO 4066
ABC friends blue

TOILETBAG KIDS



↳ 23 x 20 x 10 cm
(23 x 55 x 10 cm)

☐ 31

VE/UNIT 6/36

• Der Kinder-Kulturbeutel für alle Reisen und zu Hause

- Hauptfach aus Netzmaterial mit 3 Steckschlaufen, 1 Reißverschluss tasche, Steckfach und Gummischlaufe
- Aufhängen und fertig!
- cats and dogs: Spiegel innen
- panda/tiger: mit hochwertiger Bestickung + Namensschild innen
- Material: hochwertiges, reißfestes Polyestergewebe, wasserabweisend
- Recyceltes Obermaterial: robustes Polyestergewebe aus recycelten PET-Flaschen, wasserabweisend

• Children's toiletries bag for holidays and home

- Main mesh compartment with 3 holders, 1 zip pocket, compartment and elastic holder
- Hang it up and go!
- cats and dogs: mirror inside
- panda/tiger: with premium embroidery + name tag inside
- Material: premium-quality, tear-proof polyester, water-repellent
- Recycled outer material: robust polyester fabric made from recycled PET bottles, water-repellent

• Trousse de toilette pour enfants, à utiliser chez soi ou en voyage

- D'une contenance insoupçonnée avec son compartiment principal en filet, 3 compartiments additionnels, une poche zippée et une boucle caoutchoutée pour la suspendre
- S'accroche tout simplement à l'endroit souhaité!
- cats and dogs: Le petit plus : miroir à l'intérieur
- panda/tiger: avec une broderie de haute qualité + porte-nom à l'intérieur
- Matière : polyester de haute qualité, indéchirable et déperlant
- Matière principale recyclé : robuste tissu polyester fabriqué à partir de bouteilles PET recyclées, déperlant



WH 3072
panda dots pink



WH 4077
tiger navy



WH 3064
cats and dogs rose



WH 4062
cats and dogs mint

ALLROUNDER XS KIDS



└ 27 x 21 x 12 cm
□ 5 l

VE/UNIT 4/24

• XS-Liebling to go

- Stauraum und 3 Innentaschen für den perfekten Überblick
- Große, praktische Öffnung mit Reißverschluss
- panda/tiger: mit hochwertiger Bestickung
- cats and dogs: reflektierende Elemente für bessere Sichtbarkeit bei Dunkelheit und schlechtem Wetter
- Voll bequem! Extraweiche Tragehenkel plus Tragegurt
- Material: hochwertiges, reißfestes Polyestergewebe, wasserabweisend
- Recyceltes Obermaterial: robustes Polyestergewebe aus recycelten PET-Flaschen, wasserabweisend

• XS darling to go

- Storage space and 3 inside pockets for a perfect overview
- Large and practical zip opening
- panda/tiger: with premium embroidery
- cats and dogs: reflective elements for better visibility in the dark and in bad weather
- Super comfy! Extra-soft carrying handle plus strap
- Material: high-quality, tear-proof polyester, water-repellent
- Recycled outer material: robust polyester fabric made from recycled PET bottles, water-repellent

• L'allrounder préféré à emporter

- Espace de rangement avec 3 poches intérieures pour une parfaite organisation
- Grande ouverture pratique avec fermeture zippée
- panda/tiger : avec une broderie de haute qualité
- cats and dogs : éléments réfléchissants pour une meilleure visibilité dans l'obscurité et par mauvais temps
- Super confortable ! Poignées et bandoulière extra douces
- Matière : polyester de haute qualité, indéchirable et déperlant
- Matière principale recyclé : robuste tissu polyester fabriqué à partir de bouteilles PET recyclées, déperlant



IQ 3072
panda dots pink



IQ 4077
tiger navy



IQ 3064
cats and dogs rose



IQ 4062
cats and dogs mint

ALLROUNDER M KIDS

**BEST
SELLER**

↳ 40 x 33,5 x 24 cm
□ 18 l

VE/UNIT 2/12

• **Die Reisetasche für (fast) alle Gelegenheiten!**

- Jede Menge Stauraum und 6 Innensteckfächer für alle Lieblingsachen
- Große, praktische Öffnung mit Reißverschluss
- Leichte Polsterung an Wänden und Boden
- Voll bequem! 2 Tragehenkel und Tragegurt mit gepolsterter Schulterauflage
- Die rückseitige Steckklappe hält an allen Reisetrolley-Griffen
- Mit tierisch coolem Motiv auf der Außentasche
- panda/tiger: mit hochwertiger Bestickung
- ABC friends: reflektierende Elemente für bessere Sichtbarkeit
- Material: hochwertiges, reißfestes Polyestergewebe, wasserabweisend
- Recyceltes Obermaterial: robustes Polyestergewebe aus recycelten PET-Flaschen, wasserabweisend

• **The travel bag for (nearly) all occasions!**

- Plenty of space and 6 inside pockets for all of your favourite items
- Large and practical zip opening
- Light padding on sides and base
- Highly comfortable! 2 carrying straps and padded shoulder strap
- Rear strap for attaching to trolley suitcases
- With an incredibly cool motif on the outer pocket
- panda/tiger: with premium embroidery
- ABC friends: reflective elements
- Material: premium-quality, tear-proof polyester, water-repellent
- Recycled outer material: robust polyester fabric made from recycled PET bottles, water-repellent

• **Le sac de voyage idéal pour (presque) toutes les occasions!**

- Un maximum de place avec 6 compartiments intérieurs pour ranger toutes ses affaires préférées
- Grande ouverture pratique avec fermeture zippée
- Léger rembourrage des parois et du fond
- Super confortable! 2 anses et une bandoulière rembourrée avec renfort au niveau de l'épaule
- Languette au dos pour fixer le sac sur les poignées d'une valise à roulettes
- Motifs animaux sympatiques sur la poche extérieure
- panda/tiger : avec une broderie de haute qualité
- ABC friends : éléments réfléchissants
- Matière : polyester de haute qualité, indéchirable et déperlant
- Matière principale recyclé : robuste tissu polyester fabriqué à partir de bouteilles PET recyclées, déperlant



IX 3072
panda dots pink

IX 4077
tiger navy

IX 3064
cats and dogs rose

IX 4062
cats and dogs mint

IX 3066
ABC friends pink

IX 4066
ABC friends blue



reishethel

TROLLEY XS KIDS



↳ 29 x 43 x 18 cm
29 x 75 x 18 cm (extended)
□ 19 l

VE/UNIT 1/4

• Der lässig-coole Trolley – zum Verreisen oder Spielen!

- Superstabil und mühelos bewegbar
- Für Kleine und Große: höhenverstellbarer Teleskopgriff
- 2 große Hauptfächer mit Spanngurt und Netzfach
- Namensschild
- panda/tiger: mit hochwertiger Bestickung
- cats and dogs/ABC friends: reflektierende Elemente für bessere Sichtbarkeit
- Belastbar bis 12 kg
- Maximale Griffhöhe: 84 cm
- Material: hochwertiges, reißfestes Polyestergewebe, wasserabweisend
- Recyceltes Obermaterial: robustes Polyestergewebe aus recycelten PET-Flaschen, wasserabweisend

• The casual-cool trolley suitcase – for travel or play!

- Ultra-stable, ultra-mobile
- Suits all heights: height-adjustable telescopic handle
- 2 large main compartments with elastic straps and net pocket
- Name tag
- panda/tiger: with premium embroidery
- cats and dogs/ABC friends: reflective elements
- Loadable up to 12 kg
- Maximum handle height: 84 cm
- Material: premium-quality, tear-proof polyester, water-repellent
- Recycled outer material: robust polyester fabric made from recycled PET bottles, water-repellent

• Un sac à roulettes incroyablement cool, que ce soit pour jouer ou pour voyager !

- Hyper stable, il se déplace sans effort
- Pour petits et grands : poignée télescopique de hauteur réglable
- D'une contenance insoupçonnée avec ses 2 grands compartiments principaux munis de sangles et son compartiment en filet
- Porte-nom
- panda/tiger : avec une broderie de haute qualité
- cats and dogs/ABC friends : éléments réfléchissants
- Résistant jusqu'à 12 kg
- Hauteur maximale de la poignée : 84 cm
- Matière : polyester de haute qualité, indéchirable et déperlant
- Matière principale recyclée : robuste tissu polyester fabriqué à partir de bouteilles PET recyclées, déperlant



IL 3072
panda dots pink



IL 4077
tiger navy



IL 3064

cats and dogs rose



IL 4062
cats and dogs mint



IL 3066
ABC friends pink



IL 4066
ABC friends blue

BABYCASE



↳ 24 x 15,5 x 10 cm
 □ 3 l
 ☑ machine wash cold

VE/UNIT 6/36

• **Unser Wickelcase: alles aufgeräumt und schnell zur Hand – für gut organisierte Eltern**

- 2 separate Taschen für Cremes, Schnuller und andere Kleinigkeiten
- Gummizug innen zum Verstauen von Feuchttüchern
- Großes Einsteckfach für Windeln
- Separate Wickelunterlage
- Separater Beutel mit Kordelzug zum Aufbewahren von Schmutzwäsche
- Material: hochwertiges Polyester-gewebe, wasserabweisend

• **Our diaper case: everything cleared away and ready to hand – for well-organised parents**

- 2 separate pockets for creams, pacifiers and other odds and ends
- Interior elastic band for storing baby wipes
- Large pocket for nappies
- Separate changing pad
- Separate drawstring pouch for storing dirty clothes
- Material: premium-quality, tear-proof polyester, water-repellent

• **Notre sac à langer : tout est rangé et à portée de main – pour les parents bien organisés**

- 2 poches séparées pour les crèmes, la tétine et autres petites affaires
- Bande élastique à l'intérieur pour ranger les lingettes
- Grande poche de rangement pour les couches
- Tapis à langer séparé
- Sac avec cordelette séparé pour ranger le linge sale
- Matière : polyester de haute qualité, déperlant



IR 7052
twist silver

BABY ORGANIZER



↳ 50 x 30 x 20 cm

☐ 15 l

VE/UNIT 2/12

• Multifunktionale Wickeltasche

- Kinderwagenbefestigung
- Große Öffnung mit Reißverschluss und gepolsterter Boden
- 2 Tragegrößen
- Abnehmbarer, längenverstellbarer Schultergurt
- 4 Seitentaschen außen, 6 Steckfächer innen
- Gepolsterte Wickelunterlage, Beutel mit Kordelzug für Wäsche, isolierter Flaschenhalter mit Klett (Maschinenwäsche kalt)
- Material: hochwertiges Polyester-gewebe, wasserabweisend

• Multifunctional diaper bag

- Features attachments for stroller
- Large zip opening and padded base
- 2 carrying handles
- Detachable shoulder strap with adjustable length
- 4 pockets on the outside, 6 compartments on the inside
- Padded changing mat, pouch with drawstring for laundry, insulated bottle holder with Velcro fastener (machine wash cold)
- Material: premium-quality polyester, water-repellent

• Sac à langer multifonction

- Fixation pour poussette
- Grande ouverture zippée et fond rembourré
- 2 poignées
- Bandoulière amovible et réglable en longueur
- 4 poches latérales extérieures, 6 compartiments intérieurs
- Tapis à langer rembourré, sac avec cordelette pour le linge, porte-biberon isotherme avec velcro (lavage à froid en machine)
- Matière : polyester de haute qualité, déperlant



JB 7052
twist silver

REISENTHEL STICK- SERVICE



REISENTHEL EMBROIDERY | BRODERIE

Produkte individuell zu personalisieren ist ein Megatrend. Auch wir nehmen reisenstiel ganz persönlich: mit unserem Stick-Service, mit dem Sie und Ihr Kunde sein einzigartiges Lieblingsstück kreieren und über das B2B-Portal bestellen können. Mehr Informationen dazu erhalten Sie von Ihrem Innendienstmitarbeiter.

Individual product personalisation is a major trend. We can also personalise your reisenstiel pieces with our embroidery service, allowing you to create a unique showpiece for your customer and order it via the B2B portal. For more information, please get in touch with your office representative.

La personnalisation de produits est la grande tendance du moment. Chez reisenstiel aussi, nous aimons la personnalisation : grâce à notre service de broderie, créez le modèle unique qui ravira votre client et commandez-le via le portail B2B. Votre collaborateur du service interne se tient à votre disposition pour plus d'informations à ce sujet.



-  Einzigartige Lieblingsstücke, schnell und einfach personalisiert
Unique favourites personalised quickly and easily
Des pièces uniques, personnalisées rapidement et en toute simplicité
-  Tolle Geschenkidee
A fantastic gift idea | Une excellente idée cadeau
-  Pro Bestickung nur 7,95 €*
Only €7.95* per embroidery | 7,95 €* seulement par broderie

b2b.reisenstiel.com/stick-service



Bestickbare Produkte** | Embroidery** | Broderie**:



carrybag



re-shopper 1



shoulderbag S



shopper M



shopper XL



shopper e1



allday backpack M



allrounder R



allrounder cross



allrounder S pocket



allrounder M (kids)



allrounder L



allrounder L pocket



activitybag

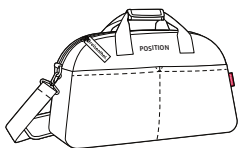

overnighter

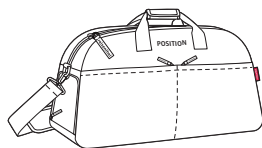

overnighter plus



netbookbag



workbag



babycase



baby organizer

* UVP – unverbindliche Preisempfehlung. | ** Platzierung der Bestickung und maximale Zeichenzahl sind vorgegeben.

* RRP – recommended retail price | ** Placement of embroidery and maximum number of characters are specified

* PVC – prix de vente conseillé | ** L'emplacement de la broderie et le nombre maximum de caractères sont prédéfinis



OUR BRANDING BESTSELLER

Möglichkeiten der Individualisierung:

- Transferdruck
- Siebdruck
- Stickerei
- Gravuren (Aluminiumteile)

Sonderproduktionen:

- Weblabel
- Rubber-Patch
- Produkte in Ihrer eigenen Farbgestaltung

Individualisation options:

- Transfer printing
- Silkscreen
- Embroidery
- Engraving (aluminium parts)

Special productions:

- Web label
- Rubber patch
- Products in your own colour design

Possibilités de personnalisation :

- Impression par transfert
- Sérigraphie
- Broderie
- Gravures (pièces en aluminium)

Productions spéciales :

- Logo cousu
- Écusson en caoutchouc
- Produits dans votre propre agencement de couleurs

CONTACT

Germany

Christian Krieger
Tel. +49 8105 77292-240
Fax +49 8105 77292-920
c.krieger@reisenthel.de

Claudia Parma
Tel. +49 8105 77292-242
Fax +49 8105 77292-920
c.parma@reisenthel.de

Germany and international

Valérie Völk
Tel. +49 8105 77292-241
Fax +49 8105 77292-920
v.voelk@reisenthel.de

PRESENT YOUR BRAND TO THE WORLD!



Unverwechselbar, sympathisch und Garant für geniales Design mit Style: reisenethel ist dank zahlreicher Produkt-Ikonen international als hochwertige Marke etabliert. Ob als Corporate Incentive oder als Give-away für Ihre B2B-Kommunikation bzw. Kundenbindung – eröffnen Sie Ihrer Marke neue Welten mit Ihrem Logo auf unseren reisenethel Business-, Travel- oder Shopping-Produkten!

Unmistakable, likeable and always good for ingenious design with a twist: with its numerous products, reisenethel has established itself internationally as a high-quality brand. Whether as a corporate incentive, a giveaway for your B2B communication or for customer loyalty, you can open new worlds for your brand with your logo on any of our many reisenethel business, travel or shopping products.

Inimitable, sympathique et garante d'un design ingénieux et original, reisenethel jouit d'une image de marque de grande qualité au niveau international avec ses nombreux produits emblématiques. Pour un cadeau d'entreprise ou un cadeau promotionnel dans le cadre de votre communication B2B ou de vos actions de fidélisation de la clientèle, ajoutez votre logo sur nos produits business, de voyage ou de shopping reisenethel et ouvrez de nouveaux horizons à votre marque.



Ask for our special
industry products!

More
materials
in our
PoS flyer

UPGRADE YOUR POS



ED 9082
banner logo red
30 x 140 cm

reisen thel überzeugt durch klares Design, großartige Funktionen, höchste Qualität und Nachhaltigkeit! Präsentieren Sie unsere Markenwerte ebenso plakativ, lebendig und ausdrucksstark in Ihrem Shop. Ihre Kunden werden begeistert sein! Wir haben zahlreiche kreative, aufmerksamkeitsstarke Werbemittel, die die Marke inszenieren und unsere Einzigartigkeit erlebbar machen.

Die perfekte Präsentation am POS ist ein Upgrade und zusätzlicher Benefit für Ihre Verkaufsfläche und bietet Ihren Kunden ein außergewöhnliches Shopperlebnis – wir unterstützen Sie dabei jederzeit gerne. Egal wie individuell Ihre Vorstellungen sind, wir zeigen Ihnen Lösungen, die Sie beeindrucken werden. Gerne beraten wir Sie persönlich in Ihrem Shop!

reisen thel is all about clear design, great functions, the highest quality and sustainability! Present our brand values just as eye-catching, lively and expressively in your shop. Your customers will be thrilled! We have numerous creative, attention-grabbing advertising materials to orchestrate the brand and make our uniqueness tangible.

The perfect presentation at the POS will upgrade and benefit your sales area, providing an extraordinary shopping experience for your customers – and we will give you all the support we possibly can. No matter how unique your ideas are, we will present you with a range of effective solutions to impress. We will be happy to come to your shop and offer you personal advice on-site!

reisen thel séduit grâce à ses conceptions épurées, ses fonctionnalités remarquables, son excellente qualité et pour son développement durable. Présentez ainsi les valeurs de notre marque de manière frappante, vivante et expressive dans votre magasin. Vos clients en seront ravis. Nous disposons de nombreux outils promotionnels créatifs et accrocheurs qui mettent en valeur la marque et donnent vie à notre singularité unique.

La présentation parfaite en point de vente est un atout supplémentaire notable pour votre surface de vente et procure un univers tout particulier de shopping pour vos clients. Nous vous assistons tout au long de ce processus. Quels que soient vos besoins et vos idées, nous vous proposons des solutions adaptées et percutantes. Nous nous ferons un plaisir de vous conseiller personnellement dans votre boutique !



EA 9040
acrylic display
with diverse product sheets



diverse poster
back/front



ED 9231
 sticker RPET
 ø 50 cm



EA 9315
 mesh banner



ED 9316
 ellipse display rpct
 universell

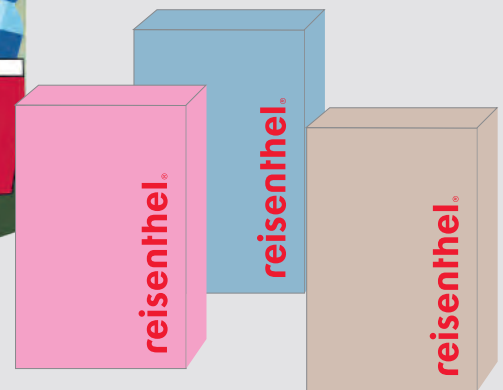

ED 9317
 deko box set
 universell

IMPRINT

Der Inhalt des Katalogs unterliegt dem Urheberrecht der Firma Reisenstheil Accessoires. Die Ausstellung, Vervielfältigung und Verbreitung der Bilder und Texte in der Öffentlichkeit ohne vorherige ausdrückliche schriftliche Genehmigung der Firma Reisenstheil Accessoires ist verboten. Bei unberechtigter Nutzung der urheberrechtlich geschützten Werke kann die Firma Reisenstheil Accessoires Unterlassung, Beseitigung der Beeinträchtigung und, wenn dem Verletzer Vorsatz oder Fahrlässigkeit zur Last fällt, diesen auch auf Schadensersatz in Anspruch nehmen.

The contents of the brochure are subject to the copyright laws of the company Reisenstheil Accessoires. It is forbidden to exhibit, reproduce or distribute the images and texts for public use or access without obtaining the express prior written permission of Reisenstheil Accessoires. Reisenstheil Accessoires is entitled to exercise its right to injunctive relief and to demand the elimination of any interference or impairment in the event of un-authorised use of the copyright material, and may also make a compensation claim for damages in the event that the violator is charged with intent or negligence.

Le contenu du catalogue est soumis aux droits d'auteur de la société Reisenstheil Accessoires. L'exposition, la reproduction et la divulgation de photos et de textes sans l'autorisation préalable formelle de la société Reisenstheil Accessoires sont interdites. En cas d'exploitation illégitime des œuvres protégées par des droits d'auteur, la société Reisenstheil Accessoires peut demander une interdiction ou la réparation du préjudice et, si le contrevenant a agi par négligence ou avec préméditation, elle peut également lui demander des dommages et intérêts.



Reisenthel Accessoires GmbH & Co. KG
Zeppelinstraße 4
82205 Gilching | Germany
Tel. +49 8105 77292-0
Fax +49 8105 77292-920
info@reisenthel.com
reisenthel.com

Order now: www.b2b.reisenthel.com

EC 9000

2022



4 012013 565779